

CSCONN[®]

The World's Leading Supplier of Connector

Today's CSCONN
The Future of You and Me !



Company Profile

CSCONN is a leading global supplier of connectors, has about 6,000 employees in over 30 countries to the global enterprises to provide performance superior products and services. We design, manufacture and market products for customers in a broad array of industries including automotive; computer; communications equipment; industrial machinery; medical; household appliances; consumer electronics; instrumentation; and military.

The company is committed to providing customers with high-quality, innovative products and "One-Stop Shopping" product solutions. thanks to the joint efforts of the staff of CSCONN and the support of our customers, the company has gradually formed Kunshan, Heyuan, Dongguan as the main R&D and production base, one after another in HongKong, Taiwan, the United States, Germany, Singapore, Japan, India, Canada and other places the establishment of sales offices to serve customers worldwide.

Science and Technology Connect Future
Quality Leads to Success



CATALOGUE

CARD SOCKET SERIES.....	01
FPC CONNECTOR SERIES.....	14
BTB CONNECTOR SERIES.....	25
USB SERIES.....	36
PHONE JACK SERIES.....	58
DC JACK SERIES.....	68
BATTERY CONNECTOR SERIES.....	75
WAFER SERIES.....	81
HDMI SERIES.....	90
RJ45 SERIES.....	92

SD CARD PUSH PUSH A TYPE

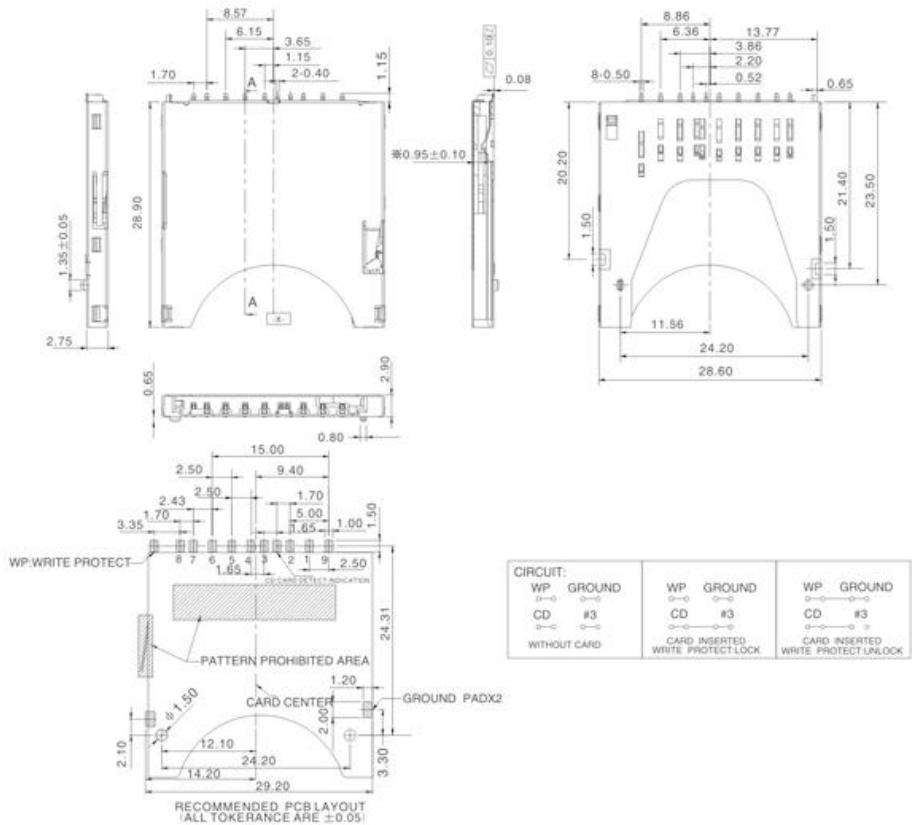

SPECIFICATION

1. Material:

Insulator: LCP, rated UL94V-0,color:black.
 Contacts: Phosphor Bronze,
 Tin 160u" at Solder Tail,
 Selected Gold on Contact Area Plating,
 Ground: Phosphor Bronze, Tin 160u".
 Shell: Stainless, Pickling

2. Electrical Characteristics:

Operating voltage : 100V AC(rms)/DC.
 Current rating : 0.5A.
 Operating Temperature: -25℃~+90℃
 Insulation resistance: 1000M ohms min. at 250VDC
 Dielectric withstanding voltage:500 VAC/1minute.
 Contact resistance: 100m ohms max.
 Mating cycle: 10000 cycles at the speed rate of
 400-600 cycles/h; Without distortion of plastic
 and serious wear and tear in terminal, No signal break.

3. Product special future symbol: "※"

SD CARD PUSH PUSH REVERSE

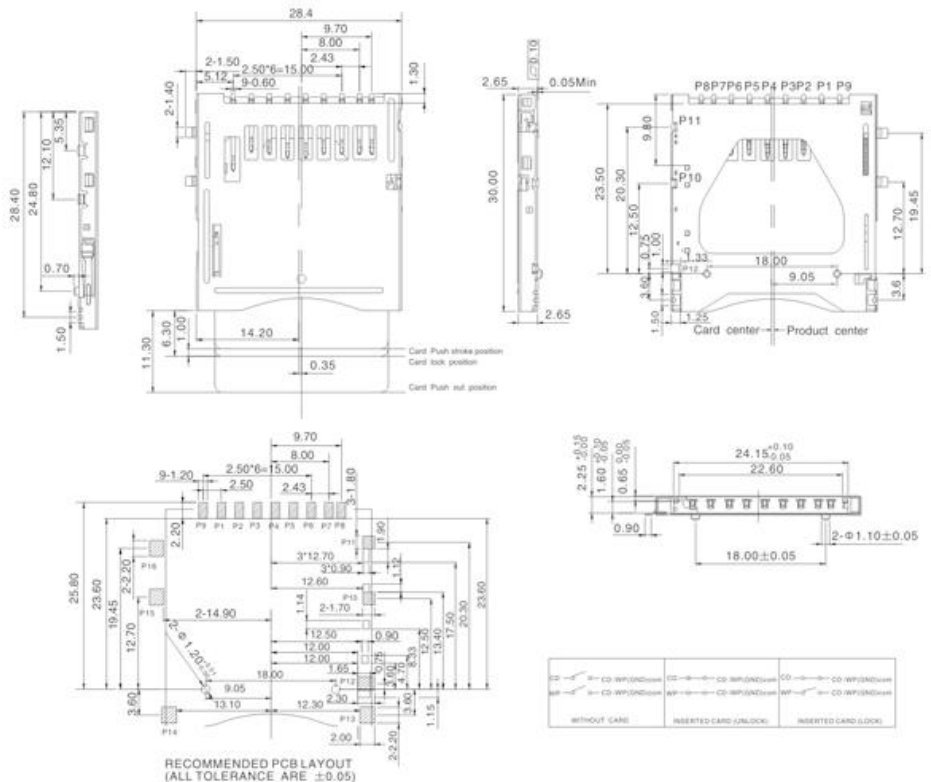

SPECIFICATION

1. Material:

Insulator: LCP , rated UL94V-0,color:black.
 Contacts: Phosphor Bronze,
 Shell: Stainless, Pickling
 Spring:SWPB.

2. Electrical Characteristics:

Operating voltage : 100V AC(rms)/DC.
 Current rating : 0.5A.
 Operating Temperature: -25℃~+80℃
 Insulation resistance: 1000M ohms min. at 250VDC
 Dielectric withstanding voltage:500 VAC/1minute.
 Contact resistance: 100m ohms max.
 Mating cycle: 10000 cycles at the speed rate of
 400-600 cycles/h; Without distortion of plastic
 and serious wear and tear in terminal, No signal break.
 Contact Retention Force:0.15kgf Minimum.

T-FLASH CARD PUSH PUSH OUTSIDE SOLDER TYPE

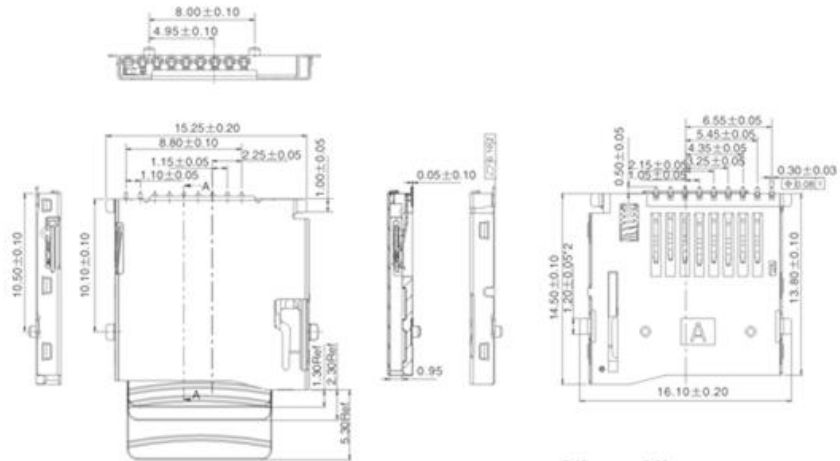

SPECIFICATION

- Material:
 - housing: LCP, UL94V-0,color:black.
 - orbit: Pa46, UL94V-0,color:black.
 - Contacts: Phosphor Bronze,
 - Tin 160u" at Solder Tail,
 - Selected Gold on Contact Area Plating.
 - Shell: Stainless. Pickling.
- Electrical Characteristics:
 - Operating voltage : 10V AC(rms)/DC.
 - Current rating : 0.5A.
 - Operating Temperature: -25°C~+85°C.
 - Insulation resistance: 1000M ohms min. at 250VDC
 - Dielectric withstanding voltage:500 VAC/1minute.
 - Contact resistance: 100m ohms max.
- Mechanical characteristics
 - Mating durability: 10000 cycles.
 - Insertion force: 30N Max.
 - Extraction force: 1~30N
 - Mating cycle: 10000 cycles at the speed rate of 400-600 cycles/h; Without distortion of plastic and serious wear and tear in terminal, No signal break.

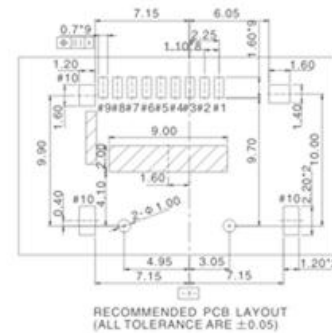

T-FLASH CARD PUSH PUSH SINKING-BOARD TYPE

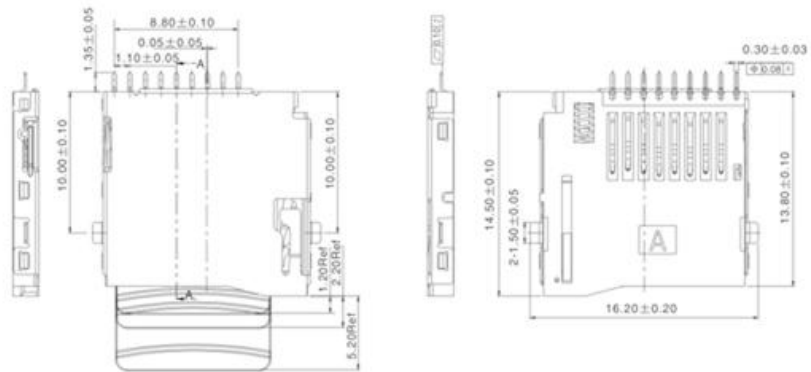

SPECIFICATION

- Material:
 - housing: LCP, UL94V-0,color:black.
 - orbit: Pa46, UL94V-0,color:black.
 - Contacts: Phosphor Bronze,
 - Tin 160u" at Solder Tail,
 - Selected Gold on Contact Area Plating.
 - Shell: Stainless. Pickling.
- Electrical Characteristics:
 - Operating voltage : 10V AC(rms)/DC.
 - Current rating : 0.5A.
 - Operating Temperature: -25°C~+85°C.
 - Insulation resistance: 1000M ohms min. at 250VDC
 - Dielectric withstanding voltage:500 VAC/1minute.
 - Contact resistance: 100m ohms max.
- Mechanical characteristics
 - Mating durability: 10000 cycles.
 - Insertion force: 30N Max.
 - Extraction force: 1~30N
 - Mating cycle: 10000 cycles at the speed rate of 400-600 cycles/h; Without distortion of plastic and serious wear and tear in terminal, No signal break.



T-FLASH CARD PUSH PUSH REVERSE

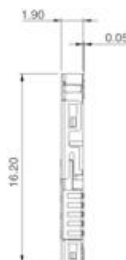
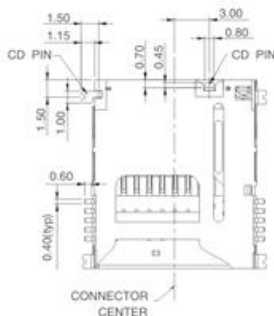
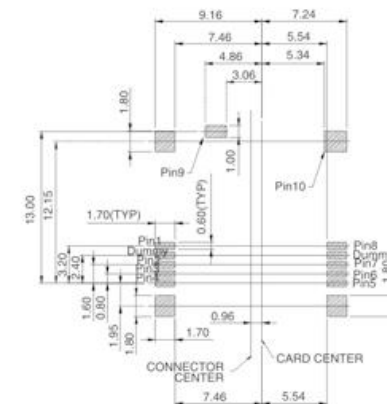
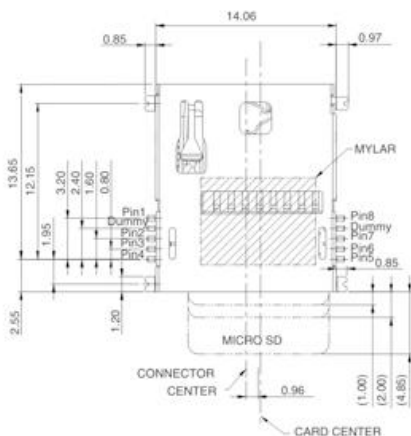

Pin No.	MICRO SD
Pin1	DAT2 1P
Pin2	CD/DAT3 2P
Pin3	CMD 3P
Pin4	VDD 4P
Pin5	CLK 5P
Pin6	VSS 6P
Pin7	DATO 7P
Pin8	DATI 8P
Pin9	CARD DETECT
Pin10	GROUND

1. Material:

- 1.1 Insulator: HIGH TEMP. PLASTIC , rated UL94V-0,color:black.
- 1.2 Terminal: Copper Alloy, Gold/Ni Plating.
- 1.3 Latch: Stainless Steel
- 1.4 Shell: Stainless steel, Gold/Flash at Solder Tail.

2. Mechanical and Electrical performance:

- 2.1 Mating Cycles: 5000cycles(speed: 400~600 cycles/h)
- 2.2 Rating current : 0.5A Max.
- 2.3 Insulation resistance: 1000MΩ Min. at 500VDC
- 2.4 Terminal contact resistance: 100mΩ Max.
- 2.5 Withstanding voltage: 250V AC at 1mA Max. for 1 minute.

3. Environment performance.

- 3.1 Operating temperature: -20℃~ +70℃
- 3.2 Storage temperature: -40℃~ +85℃

T-FLASH CARD PUSH PUSH WITH SWITCH

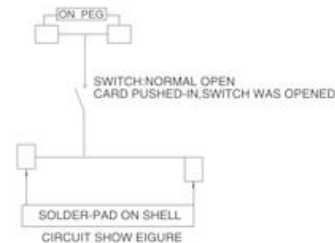
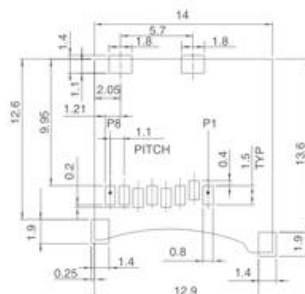
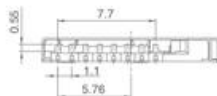
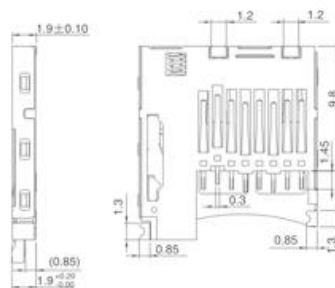
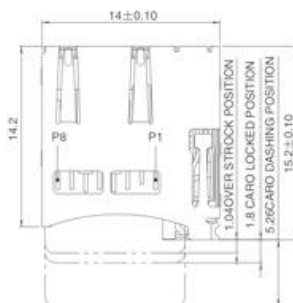

NOTE:

1. ELECTRICAL CHARACTERISTICS

- 1-1. CONTACT RESISTANCE: 80 milliohms MAX.
- 1-2. INSULATION RESISTANCE: 1,000 Megohms MIN.
- 1-3. DIELECTRIC WITHSTANDING VOLTAGE: 500V AC MIN FOR 1 MINUTE.

2. MECHANICAL CHARACTERISTICS

- 2-1. RETENTION FORCE:MIN.100gf/PIN
- 2-2. DURABILITY: 5,000 CYCLES
- 2-3. PRODUCT COPMLIED WITH ROHS

PIN NO.	PIN Assignmeng	PIN NO.	PIN Assignmeng
PIN1	DAT2	PIN5	CLK
PIN2	CD/DAT3	PIN6	VSS
PIN3	CMD	PIN7	DATO
PIN4	VDD	PIN8	DATI

RECOMMEN P.C.B LAYOUT(TOP VIEW)
GENERAL TOLERANCE±0.05

T-FLASH CARD PUSH PUSH H=1.35MM SMT

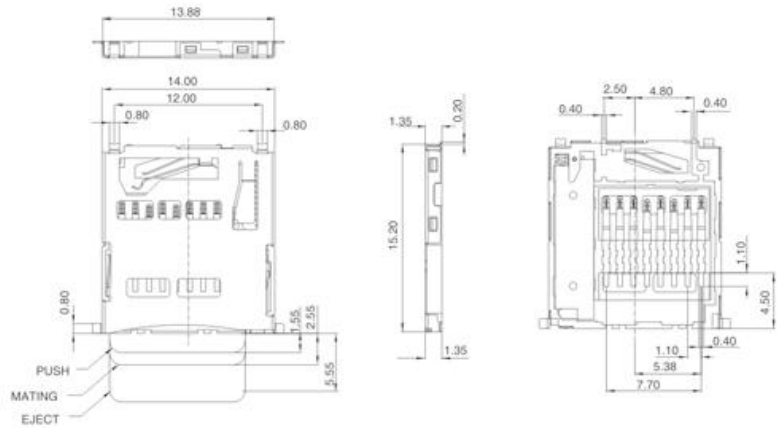

Notes:

- Coplanarity Spec.
For All Solder Tails And Solder Pads Is 0.1mm Max.
- Electrical Characteristics:
 - Current Rating: 0.5 Amp. Max.
 - Voltage: 100v Dc.max.
 - Low Level Contact Resistance: 100 Mohms Max. Initially.
 - Dielectric Withstanding Voltage: 500v Ac Min.for 1 Minute.
 - Insulation Resistance: (initial)1000mohms Min. (final) 100mohms Min.
By Applying 500v Dc On Mated And Unmated.
Connectors Through Mil-std-202.method 302
- Mechanical Characteristics
 - Durability: 5000 Cycles.
 - Operating Temp Range: -25°C to 85°C.[including Terminal Temp. Rise]
 - Storage Temp:-40°C To 85°C.
- Quantity Of Product: 1500pcs/reel
- Please Contact Hmt Sales Representative To Verify Product Details.

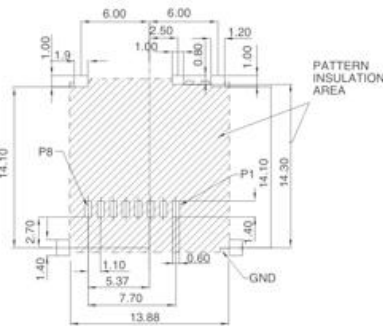

Connector pin Assignment

PIN NO.	NAME	TYPE	Description
P1	DAT2	1/0/PP	Date LINE(bit2)
P2	CD/DAT3	1/0/PP	Card Detect/Date line(bit3)
P3	CMD	PP	Command Response
P4	VDD	S	Supply Voltage
P5	CLK	I	Colck
P6	VSS	S	Supply Voltage Ground
P7	DATO	1/0/PP	Date Line(bit0)
P8	DAT1	1/0/PP	Date Line(bit1)

T-FLASH CARD PUSH PUSH H=1.45MM

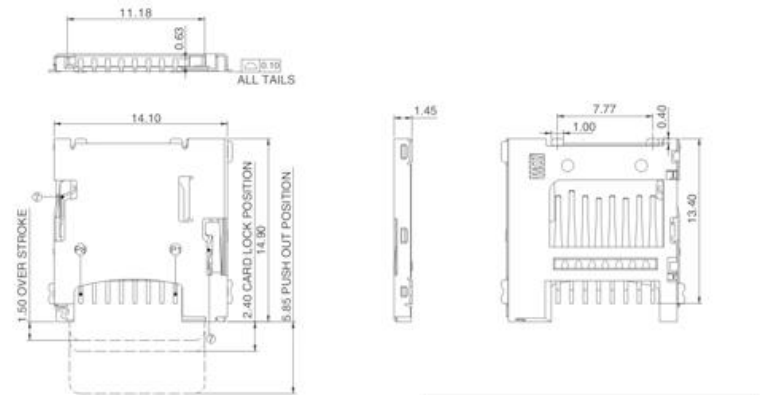

Notes:

- Electrical Characteristics
 - Contact Resistance: 50 Milliohms Max.
 - Insulation Resistance: 1,000 Megohms Min.
 - Dielectric Withstanding Voltage: 500v Ac Minfor 1 Minute.
- Mechanical Characteristics
 - Contact Normal Force:30-90gf
 - Durability: 5,000 Cycles
 - Product Copmlied With Hsf

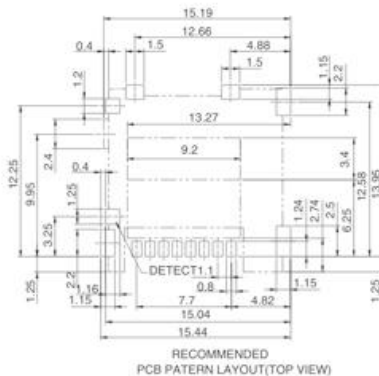

Connector pin Assignment

PIN NO.	NAME	TYPE	Description
P1	DAT2	1/0/PP	Date LINE(bit2)
P2	CD/DAT3	1/0/PP	Card Detect/Date line(bit3)
P3	CMD	PP	Command Response
P4	VDD	S	Supply Voltage
P5	CLK	I	Colck
P6	VSS	S	Supply Voltage Ground
P7	DATO	1/0/PP	Date Line(bit0)
P8	DAT1	1/0/PP	Date Line(bit1)

T-FLASH CARD H=1.8MM PEDAL-LIFT TYPE

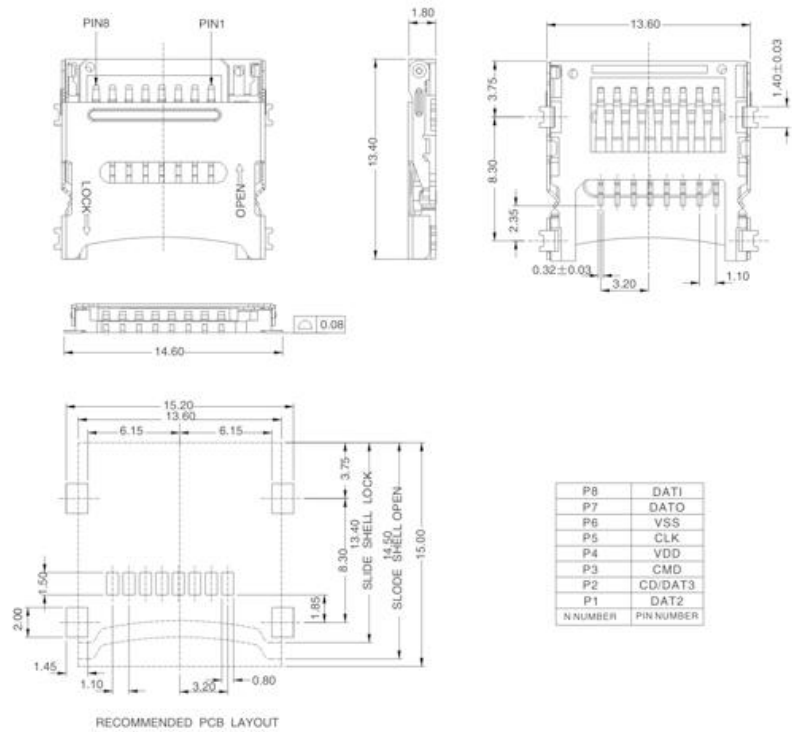

NOTES:

1. VOLTAGE RATING: 100V
2. CURRENT RATING: 0.5A
3. INSULATION RESISTANCE: 1000 MEG. OHM MAX
4. CONTACT RESISTANCE: 100MILL.OHM MAX
5. OPERATION TEMPERATURE: -20°C TO +85°C
6. DURABILITY: 5000 CYCLES

RECOMMENDED PCB LAYOUT

T-FLASH CARD H=1.6MM SIMPLE TYPE

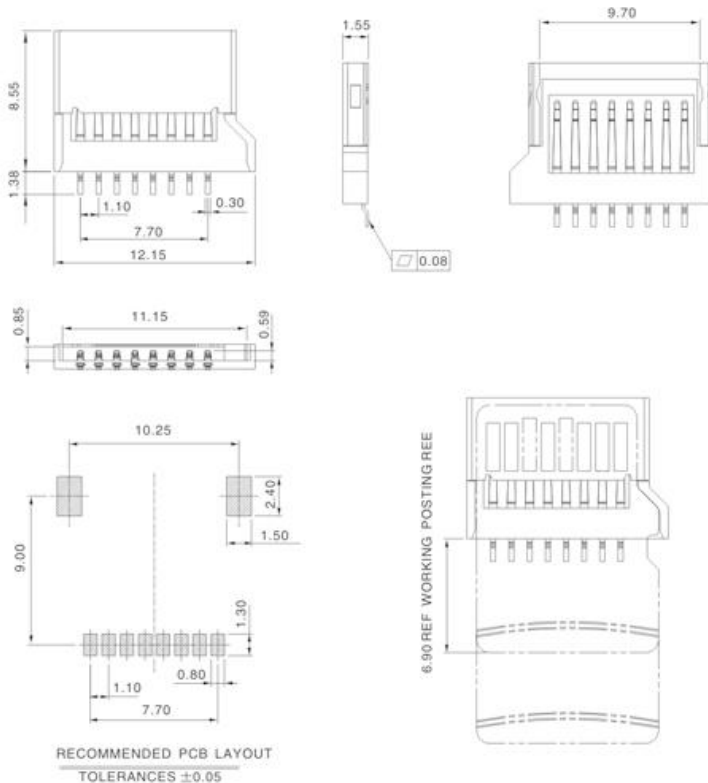

NOTES :

- 1.0 RATING.
- 1.1 VOLTAGE: 100 VAC(rms)
- 1.2 CURRENT: 0.5 AMPERES MAX. PER CONTACT
- 1.3 OPERATION TEMPERATURE RANGE: -25°C~+90°C
- 2.0 ELECTRIC CHARACTERISTIC:
- 2.1 CONTACT RESISTANCE: 100mΩ MAX.
- 2.2 INSULATION RESISTANCE: 1000mΩ MIN.
- 2.3 DIELECTRIC WITHSTANDING VOLTAGE: 500V AC FOR 1 MINUTE
- 3.0 OPERATION LIFE: 5000CYCLEES
- 4.0 MATERIAL/FINISH: SEE TABLE A

RECOMMENDED PCB LAYOUT
TOLERANCES ±0.05

SIM CARD 6P H=1.5MM

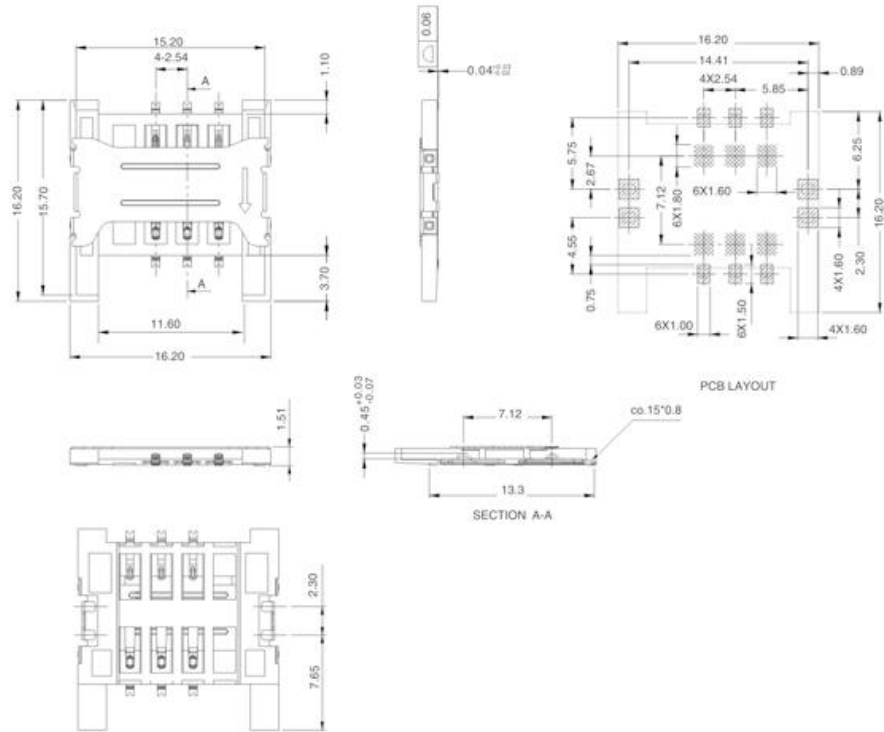

SPECIFICATIONS:

1. Electrical Characteristics:
2. Current Rating: 1AMP Max.
3. Dielectric Withstanding Voltage: 500V AC For 1Minute.
4. Contact Resistance : 40m OHMS Max.
5. Insulation Resistance: 1000M OHMS Min At 250V DC.
6. Operation Temperature:-25°C ~ +85°C.
7. Operating Voltage: 250V(AC/DC).

SIM CARD 6P H=1.8MM PEDAL-LIFT TYPE

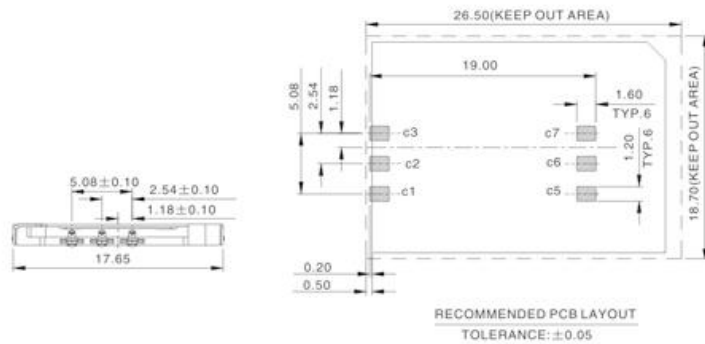

NOTES:

1. MATERIAL:
 - 1.1 Housing: High Temperature Thermoplastic UL94V-0, Color:Black
 - 1.2 Terminal:Copper Alloy,T=0.15mm
 - 1.3 Shell:Stainless Steel,T=0.20mm
2. FINISH:
 - 2.1 Terminal:Au plating on the contact area.
 - Matte Tin on the solder tails plated nickel over all.
3. SPECIALITY:
 - 3.1 Rated Current:0.5A
 - 3.2 Rated Voltage:30V
 - 3.3 Contact Resistance:50mΩ Max
 - 3.4 Insulation Resistance:100MΩ Min 100V DC
 - 3.5 Dielectric Withstanding Voltage:100V AC
 - 3.6 Solder Ability:245±5°C; 5±0.5s
 - 3.7 Durability:5000 cycles
 - 3.8 Operating Condition:
 - Temperature:-30°C~+80°C;
 - Humidity:80%R.H Max

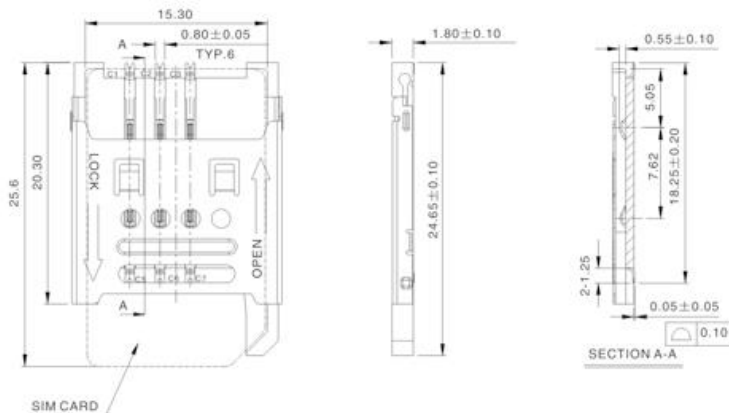

SIM CARD 6P H=2.6MM PEDAL-LIFT TYPE



TECHNICAL CHARACTERISTICS

1. General characteristics
 - Contact principle: Friction technology
 - Operating position: Shaft up/down/horizontal
 - Mounting System: Smt (Post Optional)
 - Durability: 5000 cycles min.
2. Mechanical characteristics:
 - Insulation material: Thermoplastic, UL 94V-0
3. Electrical Characteristics
 - Number of contacts (Optional): 6pins or 8pins
 - Contact resistance: 50mΩ initial, 100mΩ max
 - Insulation resistance >1000MΩ /500V DC
4. Solder ability
 - Wave: Not applicable
 - Vaporphase: 215°C, 30sec.Max
 - IR reflow: 250°C, 15sec.Max
 - Manual soldering: 360°C, 3sec.Max
5. Environmental Characteristics
 - Operating temperature: -40°C ~ +85°C
 - Operating humidity: 10% ~ +95%RH
 - Storage temperature: -40 ° C ~ +85°C
 - Storage humidity: 10% ~ +95%RH
 - Thermal shock: -40°C ~ +85°C, 5cycles.
 - Damp heat: 40°C, 90%RH, 10days.
 - Salt-mist: 35°C, 5%NaCl, 24H

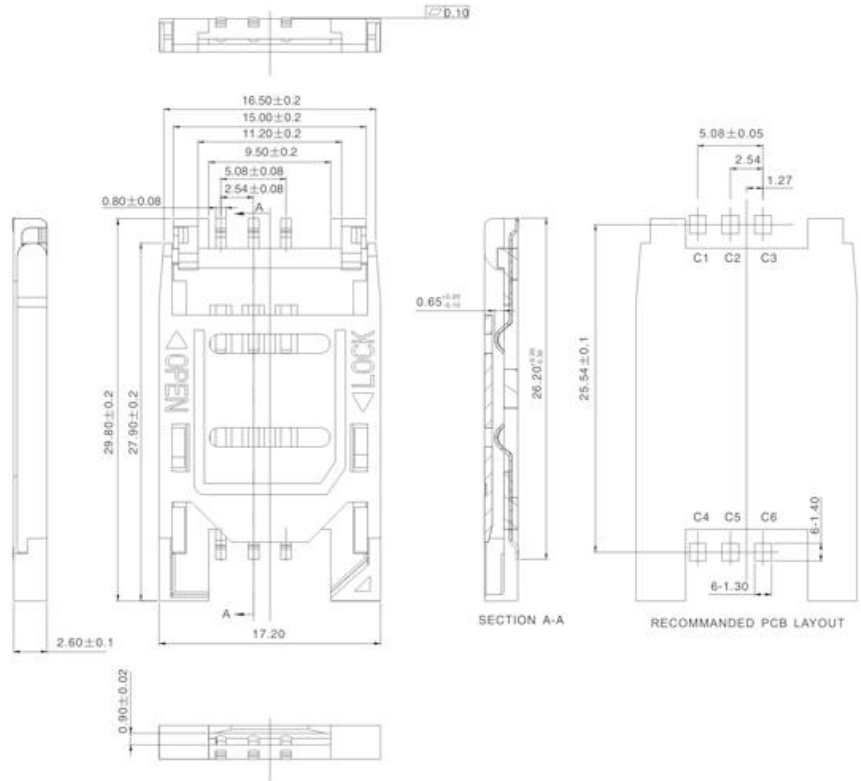

SIM CARD 8P PUSH PUSH H=1.5MM



NOTES:

- 1) MATERIAL:
 - 1-1 HOUSING: THERMOPLASTIC, UL 94V-0, COLOR: BLACK
 - 1-2 SLIDE: THERMOPLASTIC, UL 94V-0, COLOR: BLACK
 - 1-3 SHIELDED: STAINLESS STEEL
 - 1-4 CONTACT: COPPER ALLOY
 - 1-5 DETECT PIN: BRASS
 - 1-6 CAM ROD AND SPRING: STAINLESS STEEL
- 2) FINISH:
 - 2-1 CONTACT: Au PLATING ON CONTACT AREA (SEE P/N DESCRIPTION)
 - 50μ" MIN NICKEL UNDERPLATING OVER ALL
 - 100μ" MIN MATTE TIN PLATING ON SOLD AREA.
 - 2-2 SHIELDED: 1μ" MIN Au PLATING ON SECURED AREA
- 3) PRODUCT SPECIFICATIONS:
 - 3-1 VOLTAGE RATING: 50V
 - 3-2 WITHSTANDING VOLTAGE: AC250V R.M.S
 - 3-3 CURRENT RATING: 0.5A
 - 3-4 INSULATION RESISTANCE: 1000MEG.OHM MIN AT DC 250V
 - 3-5 CONTACT RESISTANCE: 100MILL.OHM MAX
 - 3-6 OPERATION TEMPERATURE: -20°C TO +85°C
 - 3-7 DURABILITY: 3000 CYCLES

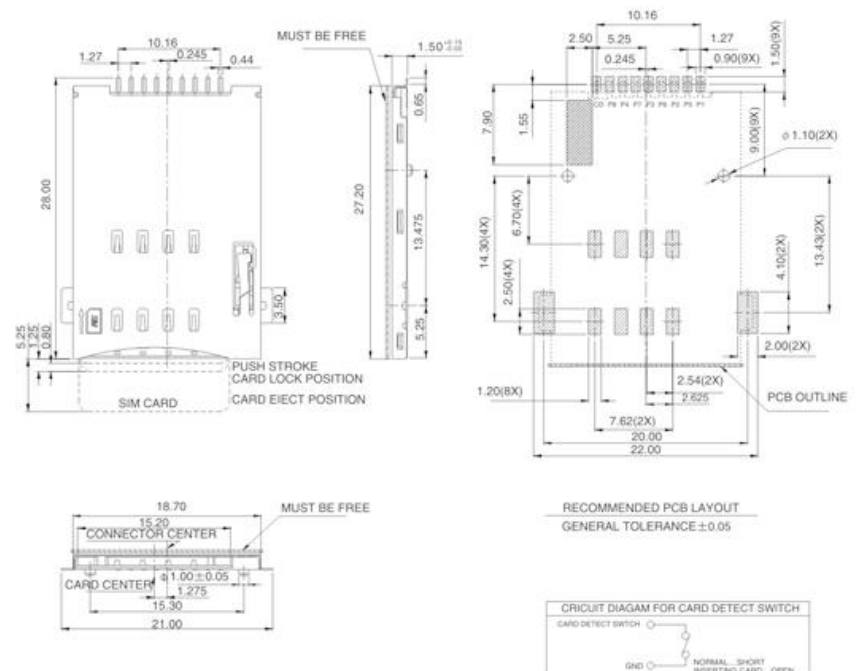

SIM CARD 6P PUSH PUSH H=1.8MM

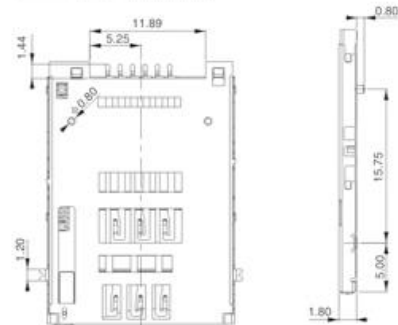
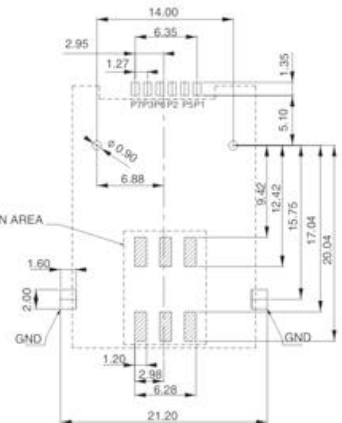
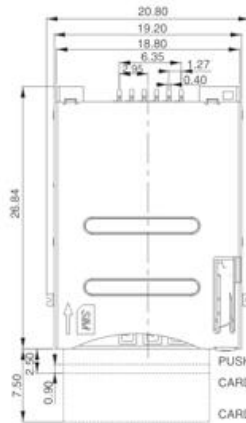

CONNECTOR TERMINAL NO.	PIN NO.
PN1	VCC PWR SIGNAL AND GND
PN2	RESET SIGNAL
PN3	CLK CLOCKING SIGNAL
PN4	GND PWR SIGNAL AND GND
PN5	VPP PROGRAMMING VOLTAGE
PN6	I/O SERIAL DATA INPUT/OUTPUT

Specification:

- *Electrical Characteristics:
 - Current Rating:0.5A
 - Withstanding Voltage:AC500V r.m.s.
 - Insulation Resistance: 1000Megohms Minimum at DC500V
 - Contact Resistance: 100Miliohms Maximum.
 - *Mechanical Characteristics:
 - Mating Cycles:3000 Insertions.
 - *Environmenttal:
 - Operating Temperature:-40°C to +60°C
 - *Material:
 - 1.Housing:HI-Temp plastic UL 94v-0 Rated.
 - 2.Contact:Copper Alloy.
 - 3.Shell:SUS.
 - *Finish:
 - 3u " Gold plated on conact area,100u " Min Tin plated on solder tails,Base Nickel:50u " Min
- DENOTES MAJOR DIMENSION MEASUREMENT REQUIRED THE PRODUCT ACCORD WITH THE REGULATION OF ROHS AND " MANAGEMENT REGYLATIONS FOR THE ENVIRONMENT RELATED SUBSTANCES AND MATERIALS "

SIM CARD 7P PUSH PUSH WITH SWITCH

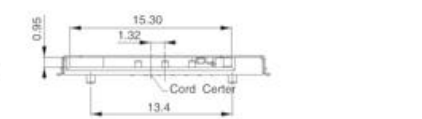
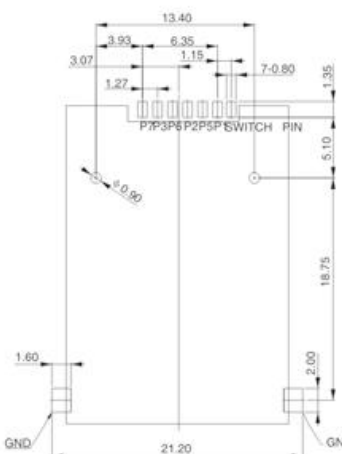
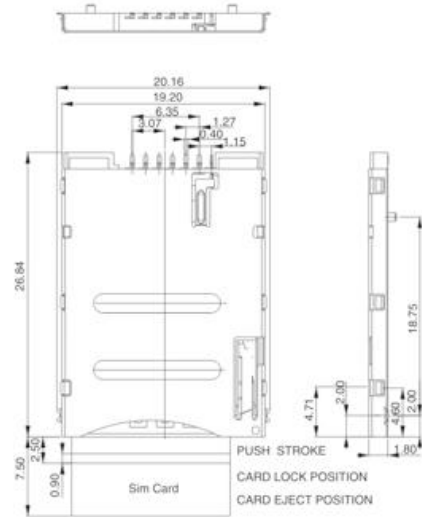

CARD DETECTION SWITCH:	
WHEN CARD IS WITHDRAWAL	WHEN CARD IS INSERTED
SHORT	OPEN

Specification:

- *Electrical Characteristics:
 - Current Rating:0.5A.
 - Withstanding Voltage:AC500V r.m.s.
 - Insulation Resistance: 1000Megohms Minimum at DC500V
 - Contact Resistance: 100Miliohms Maximum.
 - *Mechanical Characteristics:
 - Mating Cycles:3000 Insertions.
 - *Environmenttal:
 - Operating Temperature:-40°C to +60°C
 - *Material:
 - 1.Housing:HI-Temp plastic UL 94v-0 Rated.
 - 2.Contact:Copper Alloy.
 - 3.Shell:SUS.
 - *Finish:
 - 3u " Gold plated on conact area,100u " Min Tin plated on solder tails,Base Nickel:50u " Min
- THE PROODUCT ACCORD WITH THE REGULATION OF ROHS AND " MANAGEMENT REGYLATIONS FOR THE ENVIRONMENT RELATED SUBSTANCES AND MATERIALS "

MICRO SIM CARD 6P H=1.5MM

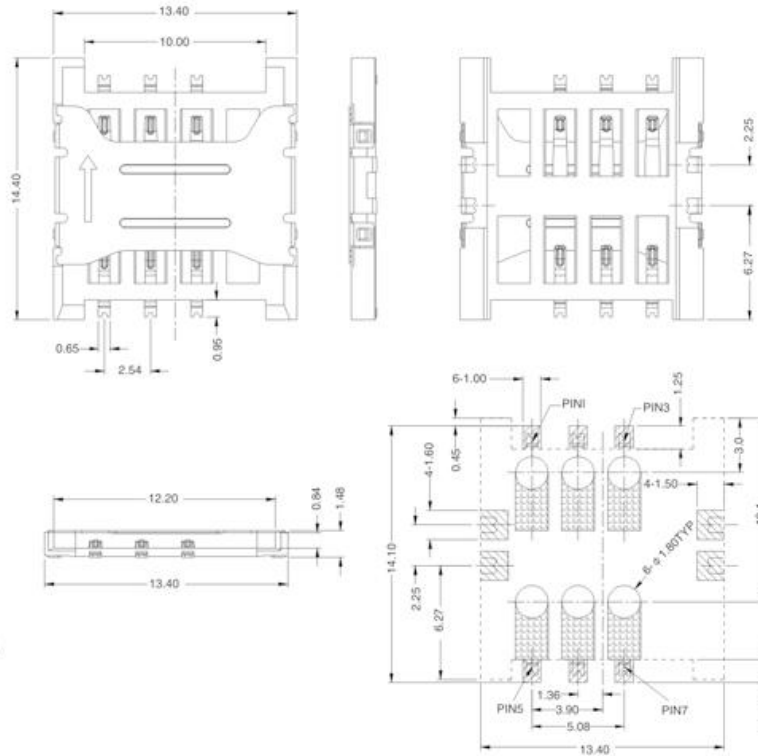

MATERIALS

- HOUSING: THERMOPLASTIC(UL 94V-0).
- TERMINAL: COPPER ALLOY,
PLATING: AND SOLDER TAILS,NICKEL PLATED OVERALL
- SHELL: SUS
PLATING:NICKEL PLATED OVERALL,
GOLD PLATED ON SOLDER TAILS

SPECIFICATIONS:

- CURRENT RATING: 0.5AMP MAX.
- DIELECTRIC WITHSTANDING VOLTAGE: 500V AC FOR 1 MINUTE.
- CONTACT RESISTANCE:40M OHMS MAX.
- INSULATION RESISTANCE :1000M OHMS MIN AT 250V DC.
- OPERATION TEMPERATURE: -25°C~+85°C.
- OPERATING VOLTAGE: 250V(AC/DC).

MICRO SIM CARD H=1.5MM

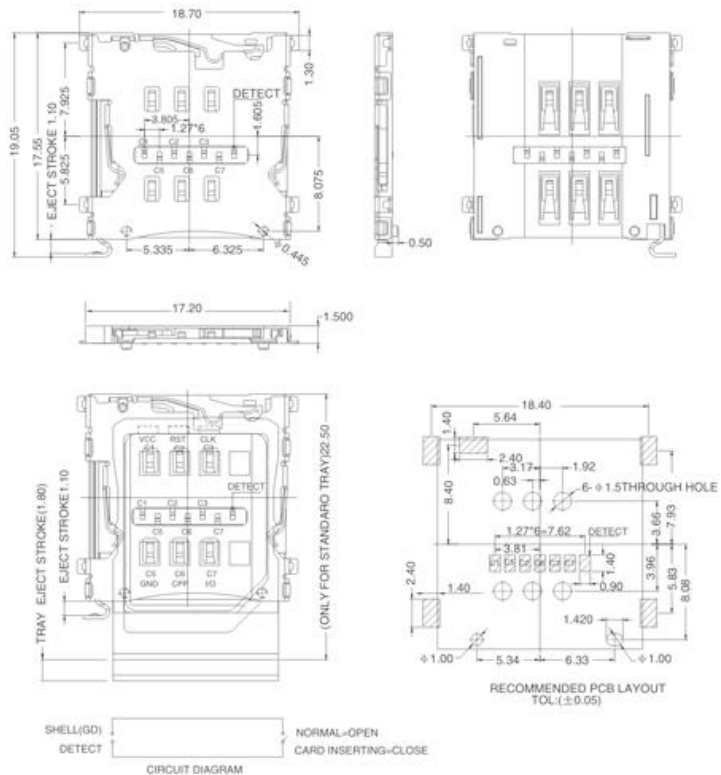

NOTE:

- MATERIAL:
 - HOUSING: LCP, UL 94V-0 COLOR: BLACK.
 - CONTACT: PHOSPHOR BRONZE T=0.15mm
 - SHELL: SUS 304 1/2H T=0.20mm
 - PUSH ROD: SUS 304 1/2H T=0.30mm
- PLATING:Underplate: 50~80u" Nickel
Contact area: 3~30u" Gold
Solder tails area:3u" Gold
Shell: 50~80u" Nickel
- ELECTRICAL CHARACTERISTICS:
 - Operating voltage: 30V(AC/DC).
 - Current rating: 1AMP MAX
 - Operating temperature:-20°C~+85°C.
 - Insulation resistance: 1000M ohme min. at 200VDC.
 - Dielectric withstanding voltage: 500 VAC/1minute.
 - Contact resistance:30m ohme max.
- MECHANICAL CHARACTERISTICS:
 - Durability:1500cycles
 - Opetating force(inserting & withdrwal): 1N~10N

MICRO SIM CARD 8P H=1.5MM PEDAL-LIFT TYPE

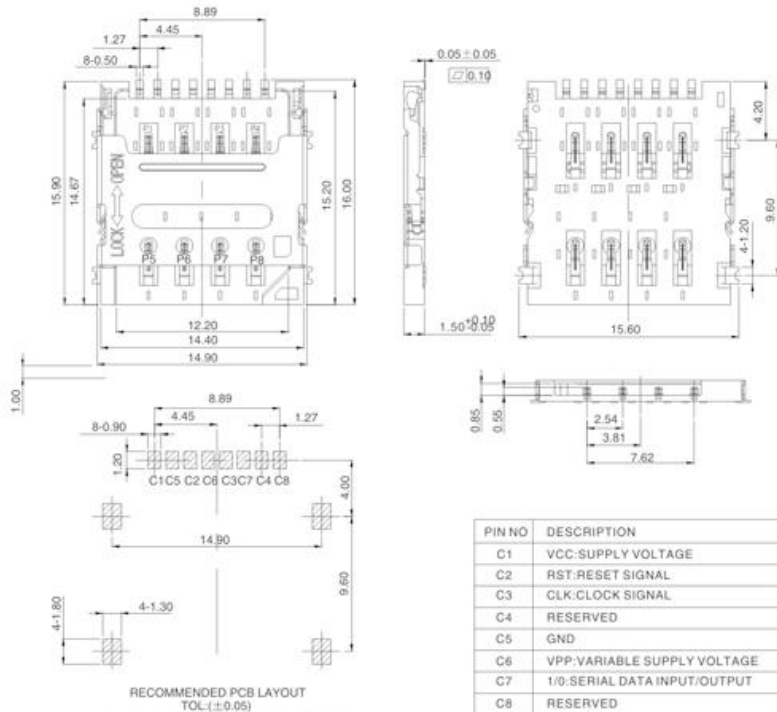

NOTES:

1. MATERIAL:

- 1.1 Housing: High Temperature Thermoplastic UL94V-0, Color: Black.
- 1.2 Terminal: Copper Alloy.
- 1.3 Shell: Stainless Steel.

2. FINISH:

- 2.1 Terminal: Plated Gold on the Contact Area and Solder Tails. Underplated Nickel Over all.
- 2.2 Shell: Plated Gold on the Solder Tails, Underplated Nickel Over all.

3. SPECIALITY:

- 3.1 Rated current: 0.5A
- 3.2 Rated voltage: 30V
- 3.3 Contact Resistance: 50mΩ MAX
- 3.4 Insulation Resistance: 100MΩ Min 100V DC
- 3.5 Dielectric Withstanding voltage: 100V AC
- 3.6 Solder ability: 235±5°C; 5±0.5s.
- 3.7 Durability: 5000 Cycles Min.

RECOMMENDED PCB LAYOUT
TOL: (±0.05)
THERE SHOULD NOT BE ANY CIRCUITRIES
IN THE LAYOUT SPACE OF THE PRODUCT

MICRO SIM CARD 6P H=1.8MM PEDAL-LIFT TYPE

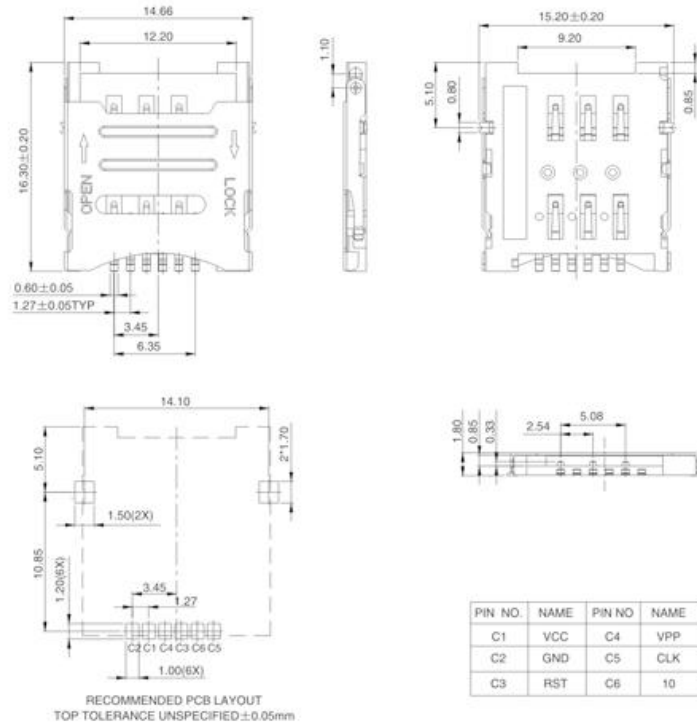

Notes:

1) Material:

- 1-1 Housing: Thermoplastic, ul 94v-0; color: black
- 1-2 Contact: Copper Alloy, T=0.15mm
- 1-3 Shielded: Stainless Steel T=0.20mm

2) Finish:

- 2-1 Contact: Gold Plating On Contact Area (see P/n Description)
100u"min Matte Sn Plating Or 1u"min Au Plating On Sold Area.
50u" Min Nickel Underplating Over All
- 2-2 Shell: 50u" Min Nickel Underplating Over All

3) Product Specifications:

- 3-1 Voltage Rating: 50v
- 3-2 Current Rating: 1.0a
- 3-3 Insulation Resistance: 1000mΩ Min
- 3-4 Contact Resistance: 50mΩ Max
- 3-5 Operation Temperature: -20°C To +85°C
- 3-6 Durability: 3000 Cycles

RECOMMENDED PCB LAYOUT
TOP TOLERANCE UNSPECIFIED ±0.05mm

MICRO SIM CARD PUSH PUSH H=1.35MM SMT

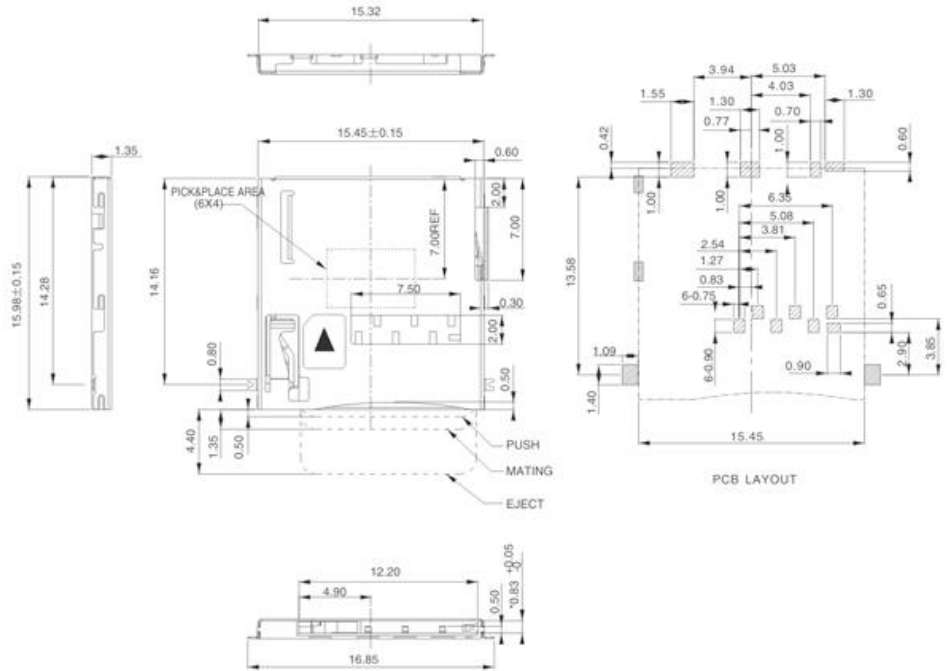

NOTES:

1. MATERIAL:
HOUSING SLIDER: THERMOPLASTIC RESIN
UL 94V-0 COLOR BLACK
CONTACT: COPPER ALLOY
SHELL: STAINLESS STEEL
COIL: SWP
CAM ROD: STAINLESS STEEL
2. FINISH CONTACT:
Au PL AT CONTACT AREA
Au PL AT SOLDERING AREA
SHELL: Au PL AT SOLDERING AND SWITCH AREA
3. NON-CUMULATIVE TOLERANCE
4. COPLANARITY IS 0.1MAX
5. CIRCUIT DRAWING OF SWITCH
6. OVERALL TOLERANCE: ±0.1

MICRO SIM CARD 6P PUSH PUSH H=1.35MM OUTSIDE SOLDER TYPE

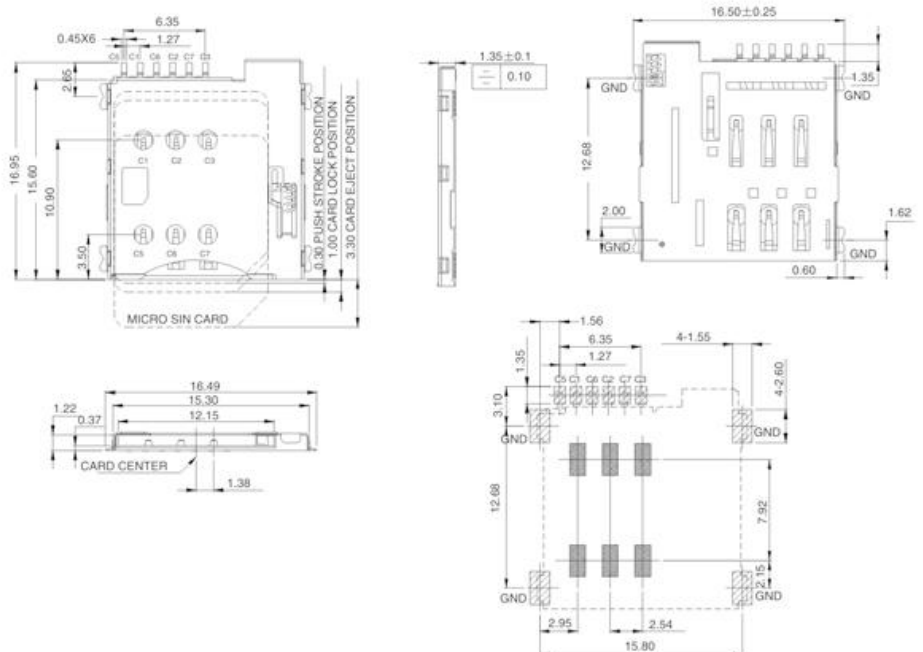

NOTES:

1. MATERIAL:
1.1 Insulator: High temperature thermoplastic, UL 94V-0.
1.2 Contact: Copper alloy
2. PLATING:
2.1 Contact: Plated 50U " Ni overall contact Au 3U "
2.2 Shell: Plated 50U " Ni overall
2.3 Plated 3U " Au selective contact area
3. ELECTRICAL:
3.1 Current Rating: 0.5mA AC/DC max.
3.2 Voltage Rating: 125V AC/DC
3.3 Ambient Temperature Range: -20°C to +60°C
3.4 Storage Temperature Range: -40°C to +70°C
3.5 Ambient Humidity Range: 95% R.H. max.
3.6 Contact Resistance: 100mΩ max.
3.7 Insulation Resistance: 1000Ω min./500VDC
3.8 Mating Cycles: 5000 insertions

NANO SIM CARD H=1.5MM PEDAL-LIFT TYPE

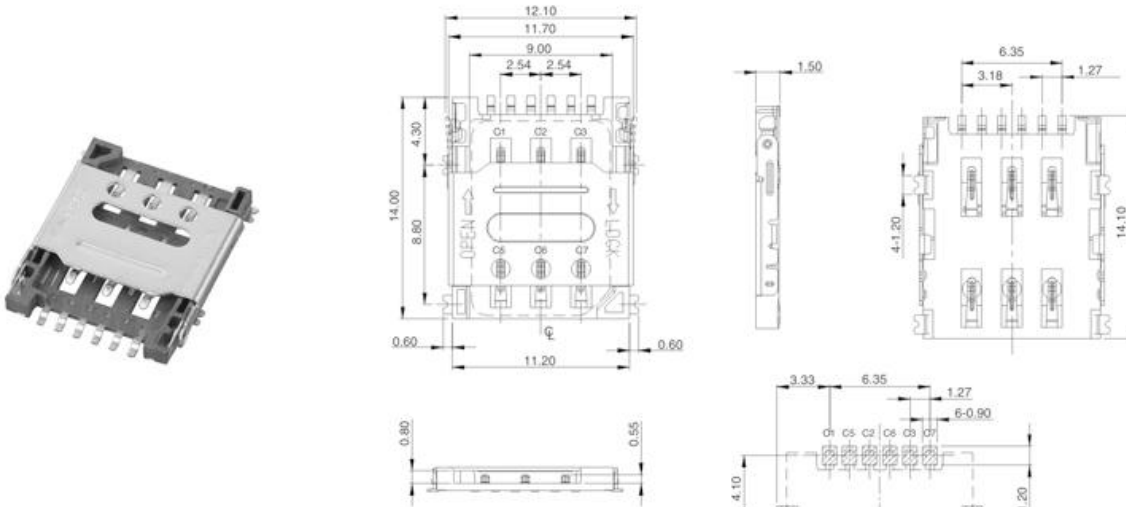

NOTES:

1. ELECTRICAL SPECIFICATIONS:
 - CURRENT RATING: 0.5A.
 - VOLTAGE RATING: 5V.
 - CONTACT RESISTANCE: 50 MILL.OHM MAX.
 - INSULATION RESISTANCE: 1000 MEG. OHM MIN.
2. MECHANICAL SPECIFICATIONS:
 - DURABILITY: 5000 CYCLES MIN.

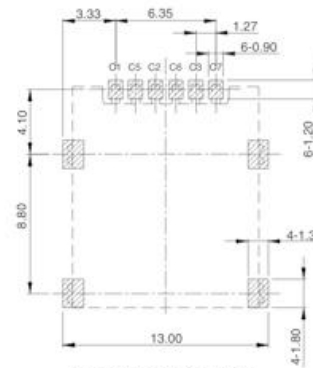

RECOMMENDED PCB LAYOUT
GENERAL TOLERANCE ± 0.05

NANO SIM CARD PUSH PUSH H=1.3MM

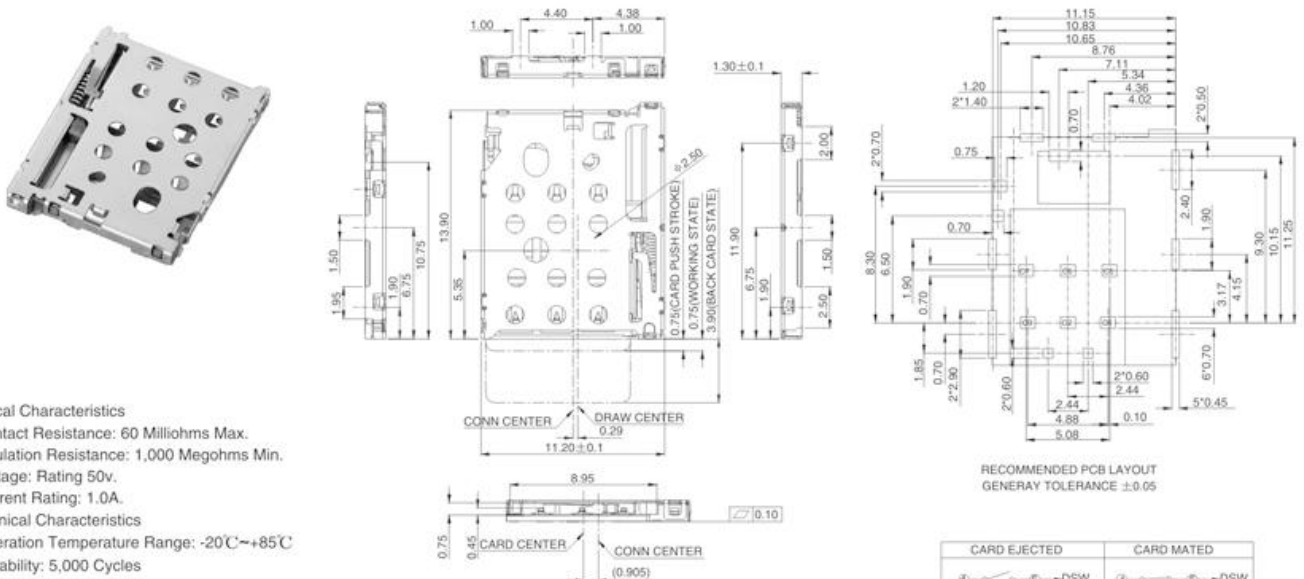

RECOMMENDED PCB LAYOUT
GENERAL TOLERANCE ± 0.05

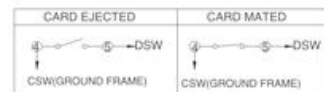

Note:

1. Electrical Characteristics
 - 1-1. Contact Resistance: 60 Milliohms Max.
 - 1-2. Insulation Resistance: 1,000 Megohms Min.
 - 1-3. Voltage: Rating 50v.
 - 1-4. Current Rating: 1.0A.
2. Mechanical Characteristics
 - 2-1. Operation Temperature Range: -20°C~+85°C
 - 2-2. Durability: 5,000 Cycles
3. Material:
 - 3-1. Housings: Thermoplastic, ul 94-v0
 - 3-2. Terminal: Phosphor Bronze,t=0.15
 - 3-3. Shell: Stainless Steel,t=0.20
4. Finished:
 - 4-1. Terminal: Ni Plated Under, 3u" Au Min Plated On Contact Area, au Plated On Solder Tail
 - 4-2. Shell: Ni Plated Under, G/F Plated On Solder Tail

DUAL SIM CARD 16P H=3.0MM

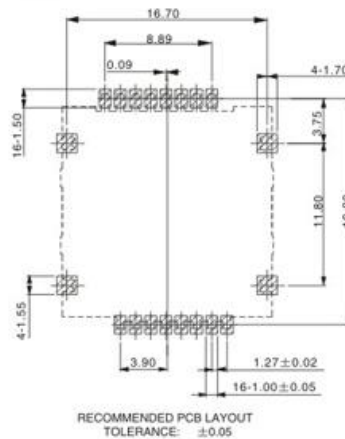
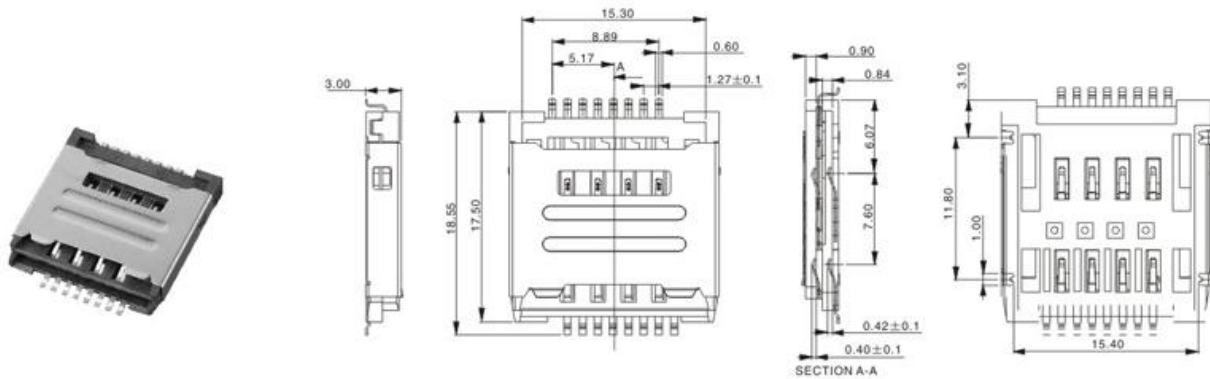

NOTES:

- 1.0 RATING.
- 1.1 VOLTAGE:12 VAC(rms)MIN.
- 1.2 CURRENT: 1 AMPERES MAX. PER CONTACT
- 1.3 OPERATION TEMPERATURE RANGE: -25°C +70°C
- 2.0 ELECTRIC CHARACTERISTIC:
- 2.1 CONTACT RESISTANCE:60mΩ MAX.
- 2.2 INSULATION RESISTANCE:1000mΩ
- 2.3 DIELECTRIC WITHSTANDING VOLTAGE:500V AC FOR 1 MINUTE
- 3.0 OPERATION LIFE: 5000 CYCLES
- 4.0 MATERIAL/FINISH:SEE TABLE

T-FLASH+MICRO SIM CARD 2IN1

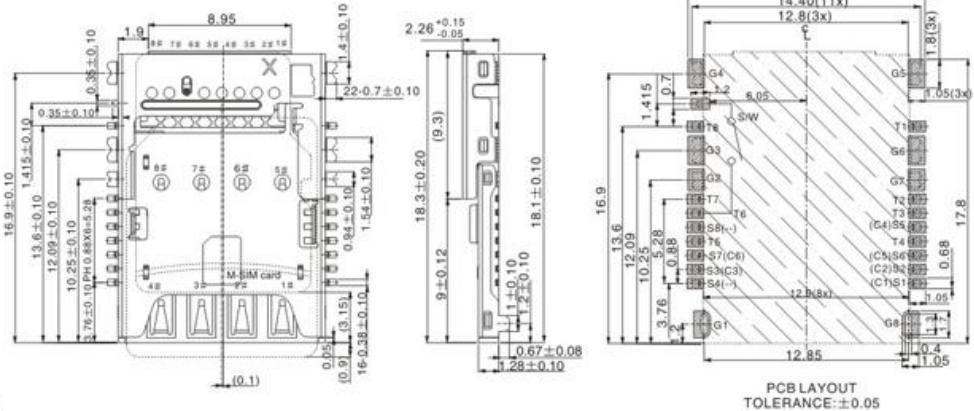

NOTES:

- 1.MATERIAL:
 - 1.1 Housing: LCP UL94V-0
 - 1.2 Terminal: Phosphor Bronze,nickel plated 50U*, Au plated 1U*.
 - 1.3 Shell:
 - 1.3.1 SIM CARD; SUS, nickel plated 50U*,Au plated 1U* in soldering Contact,
 - 1.3.2 SD CARD; SUS,nickel plated 50U*,Au plated 1U* in soldering Contact,
- 2.SPECIALITY:
 - 2.1 Rated Current:0.5A
 - 2.2 Contact Resistance:50mΩ Max
 - 2.3 Insulation Resistance:100MΩ Min 100V DC
 - 2.4 Dielectric Withstanding Voltage:100V AC
 - 2.5 Solder Ability:235±5°C; 5±0.5s

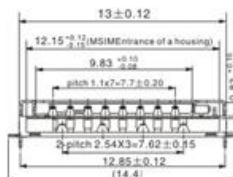

(Circuit diagram for Detection SWITCH of MicroSD card)

Card insertion condition	Card detect switch	Circuit
Without Card	Open	
Card insertion	Close	

FPC 0.3MM XP H=1.1MM BACK LOCK

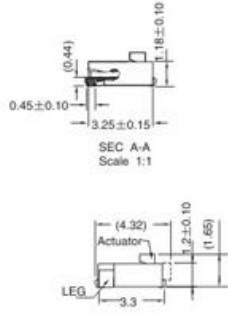
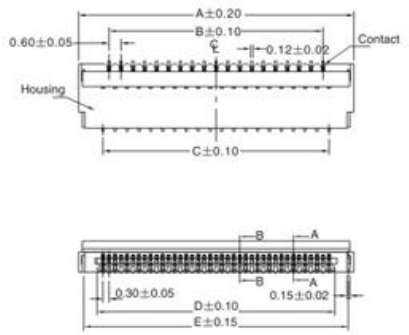

SPECIFICATION

- 1. Material:**
 Housing: HIGH-TEMP Plastic, UL94V-0,color:Natural.
 Lock: HIGH-TEMP Plastic, UL94V-0,color:black.
 Contacts: Copper alloy.
 Solder tab : Copper alloy.
- 2. Electrical Characteristics:**
 Current rating : 0.5A(max).
 Voltage rating : 50V(max).
 Operating Temperature: -25°C~+85°C.
 Insulation resistance: 500M ohms min. at 500V DC
 Dielectric withstanding voltage:500V AC/minute.
 Contact resistance: 30m ohms max.

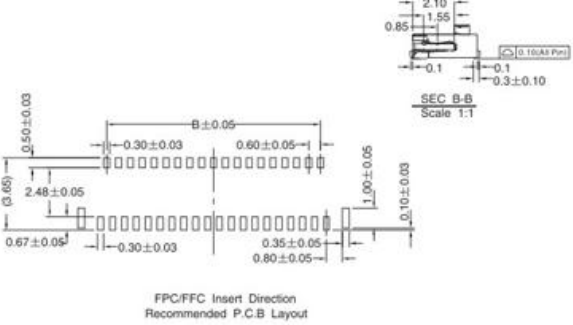

No of Contacts	Dimension				
	A	B	C	D	E
13	8.10	3.00	3.60	4.20	5.57
15	9.70	3.60	4.20	4.83	6.17
17	7.30	4.20	4.80	5.43	6.77
19	7.90	4.80	5.40	6.03	7.37
21	8.50	5.40	6.00	6.63	7.97
23	9.10	6.00	6.60	7.23	8.57
25	9.70	6.60	7.20	7.83	9.17
27	10.30	7.20	7.80	8.43	9.77
29	10.90	7.80	8.40	9.03	10.37
31	11.50	8.40	9.00	9.63	10.97
33	12.10	9.00	9.60	10.23	11.57
35	12.70	9.60	10.20	10.83	12.17
37	13.30	10.20	10.80	11.43	12.77
39	13.90	10.80	11.40	12.03	13.37
41	14.50	11.40	12.00	12.63	13.97
43	15.10	12.00	12.60	13.23	14.57
45	15.70	12.60	13.20	13.83	15.17
47	16.30	13.20	13.80	14.43	15.77
49	16.90	13.80	14.40	15.03	16.37
51	17.50	14.40	15.00	15.63	16.97
53	18.10	15.00	15.60	16.23	17.57
55	18.70	15.60	16.20	16.83	18.17
57	19.30	16.20	16.80	17.43	18.77
59	19.90	16.80	17.40	18.03	19.37
61	20.50	17.40	18.00	18.63	19.97
63	21.10	18.00	18.60	19.23	20.57
65	21.70	18.60	19.20	19.83	21.17
67	22.30	19.20	19.80	20.43	21.77
69	22.90	19.80	20.40	21.03	22.37
71	23.50	20.40	21.00	21.63	22.97
73	24.10	21.00	21.60	22.23	23.57

FPC/FPC Insert Direction
Recommended P.C.B Layout

FPC 0.3MM XP H=1.0MM PEDAL-LIFT TYPE

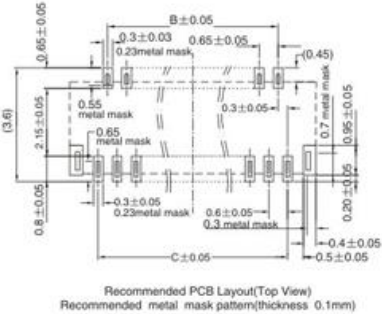
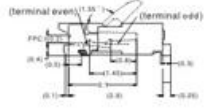
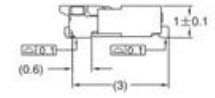
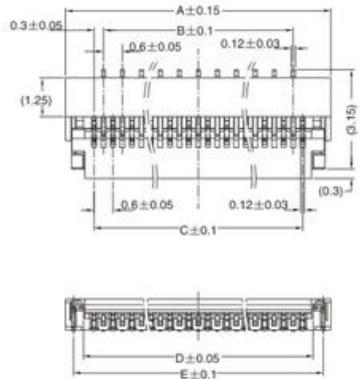

No of Contacts	DIM				
	A	B	C	D	E
09	4.20	1.80	2.40	3.03	3.70
11	4.80	2.40	3.00	3.63	4.30
13	5.40	3.00	3.60	4.23	4.90
15	6.00	3.60	4.20	4.83	5.50
17	6.60	4.20	4.80	5.43	6.10
19	7.20	4.80	5.40	6.03	6.70
21	7.80	5.40	6.00	6.63	7.30
23	8.40	6.00	6.60	7.23	7.90
25	9.00	6.60	7.20	7.83	8.50
27	9.60	7.20	7.80	8.43	9.10
29	10.20	7.80	8.40	9.03	9.70
31	10.80	8.40	9.00	9.63	10.30
33	11.40	9.00	9.60	10.23	10.90
35	12.00	9.60	10.20	10.83	11.50
37	12.60	10.20	10.80	11.43	12.10
39	13.20	10.80	11.40	12.03	12.70
41	13.80	11.40	12.00	12.63	13.30
43	14.40	12.00	12.60	13.23	13.90
45	15.00	12.60	13.20	13.83	14.50
47	15.60	13.20	13.80	14.43	15.10
49	16.20	13.80	14.40	15.03	15.70
51	16.80	14.40	15.00	15.63	16.30
53	17.40	15.00	15.60	16.23	16.90
55	18.00	15.60	16.20	16.83	17.50
57	18.60	16.20	16.80	17.43	18.10
59	19.20	16.80	17.40	18.03	18.70
61	19.80	17.40	18.00	18.63	19.30
63	20.40	18.00	18.60	19.23	19.90
65	21.00	18.60	19.20	19.83	20.50
67	21.60	19.20	19.80	20.43	21.10
69	22.20	19.80	20.40	21.03	21.70
71	22.80	20.40	21.00	21.63	22.30

Recommended PCB Layout(Top View)
Recommended metal mask pattern(thickness 0.1mm)

NOTES: MATERIAL & FINISH

- 1. MATERIAL:**
 HOUSING:LCP(UL 94V-0)
 ACTUATOR:LCP(UL 94V-0)
 TERMINAL:COPPER ALLOY
 SOLDER PIN:COPPER ALLOY
- 2. PLATING:**
 TERMINAL:GOLD FLASH 1~3u" OVER NICKEL
 SOLDER PIN:TIN OVER NICKEL(LEAD FREE)

FPC 0.5MM XP H=1.0MM BACK LOCK

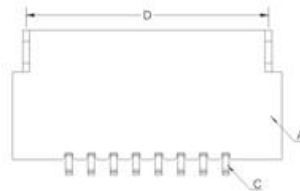
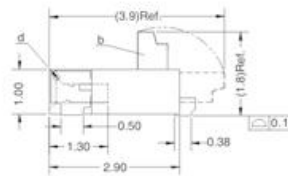
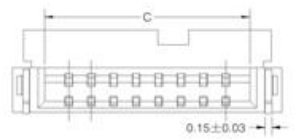
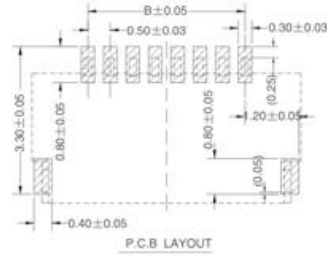
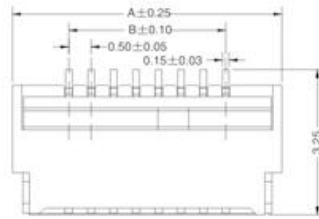

Voltage Rating : 50V AC/DC
 Current Rating : 0.4A AC/DC
 Withstand Voltage : 500V AC/minute
 Contact Resistance : 30mΩ MAX.)
 Insulation Resistance : 100MΩ MIN.)
 Temperature Range : -55°C~+85°C

Part No.	Dimension			
	A	B	C	D
4P	4.00	1.50	2.57	3.40
5P	4.50	2.00	3.07	3.90
6P	5.00	2.50	3.57	4.40
8P	6.00	3.50	4.57	5.40
10P	7.00	4.50	5.57	6.40
12P	8.00	5.50	6.57	7.40
14P	9.00	6.50	7.57	8.40
16P	10.00	7.50	8.57	9.40
18P	11.00	8.50	9.57	10.40
20P	12.00	9.50	10.57	11.40
22P	13.00	10.50	11.57	12.40
24P	14.00	11.50	12.57	13.40
26P	15.00	12.50	13.57	14.40
28P	16.00	13.50	14.57	15.40
30P	17.00	14.50	15.57	16.40
32P	18.00	15.50	16.57	17.40
34P	19.00	16.50	17.57	18.40
38P	21.00	18.50	19.57	20.40
40P	22.00	19.50	20.57	21.40
45P	24.50	22.00	23.07	23.90
50P	27.00	24.50	25.57	26.40

FPC 0.5MM XP H=1.0MM PEDAL-LIFT TYPE

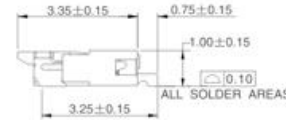
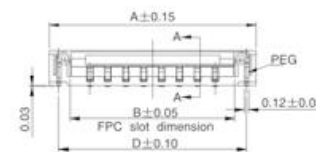
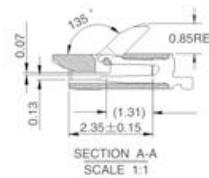
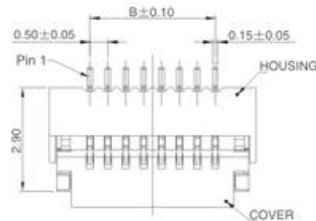

NOTE:
 1. MATERIAL:
 HOUSING: HIGHT-TEMP PLASTIC.
 UL 94V-0,COLOR:WHITE;
 COVER:HIGHT-TEMP PLASTIC.
 UL 94V-0,COLOR:BLUE;
 PEG: COPPER ALLOY;
 2.PLATING:
 CONTACT: GOLD OR TIN PLATED
 ON NICKEL OVERALL.
 PEG:TIN PLATED ON NICKEL OVERALL.
 3.RATING:
 CURRENT RATING:0.4A AC/DC\
 VOLTAGE RATING:50V AC/DC
 TEMPERATURE RANGE:-55°C ~+85°C

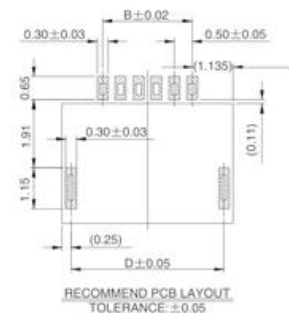

PIN NO.	DIM A	DIM B	DIM C	DIM D
04	3.77	1.50	2.60	3.27
05	4.27	2.00	3.10	3.77
06	4.77	2.50	3.60	4.27
07	5.27	3.00	4.10	4.77
08	5.77	3.50	4.60	5.27
09	6.27	4.00	5.10	5.77
10	6.77	4.50	5.60	6.27
11	7.27	5.00	6.10	6.77
12	7.77	5.50	6.60	7.27
13	8.27	6.00	7.10	7.77
14	8.77	6.50	7.60	8.27
15	9.27	7.00	8.10	8.77
16	9.77	7.50	8.60	9.27
17	10.27	8.00	9.10	9.77
18	10.77	8.50	9.60	10.27
19	11.27	9.00	10.10	10.77
20	11.77	9.50	10.60	11.27
21	12.27	10.00	11.10	11.77
22	12.77	10.50	11.60	12.27
23	13.27	11.00	12.10	12.77
24	13.77	11.50	12.60	13.27
25	14.27	12.00	13.10	13.77
26	14.77	12.50	13.60	14.27
27	15.27	13.00	14.10	14.77
28	15.77	13.50	14.60	15.27
29	16.27	14.00	15.10	15.77
30	16.77	14.50	15.60	16.27
31	17.27	15.00	16.10	16.77
32	17.77	15.50	16.60	17.27
33	18.27	16.00	17.10	17.77
34	18.77	16.50	17.60	18.27
35	19.27	17.00	18.10	18.77
36	19.77	17.50	18.60	19.27
37	20.27	18.00	19.10	19.77
38	20.77	18.50	19.60	20.27
39	21.27	19.00	20.10	20.77
40	21.77	19.50	20.60	21.27
41	22.27	20.00	21.10	21.77
42	22.77	20.50	21.60	22.27
43	23.27	21.00	22.10	22.77
44	23.77	21.50	22.60	23.27
45	24.27	22.00	23.10	23.77
46	24.77	22.50	23.60	24.27
47	25.27	23.00	24.10	24.77
48	25.77	23.50	24.60	25.27
49	26.27	24.00	25.10	25.77
50	26.77	24.50	25.60	26.27

FPC 0.5MM XP H=1.2MM SMT DOUBLE CONTACT TYPE

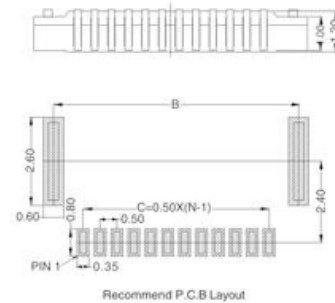
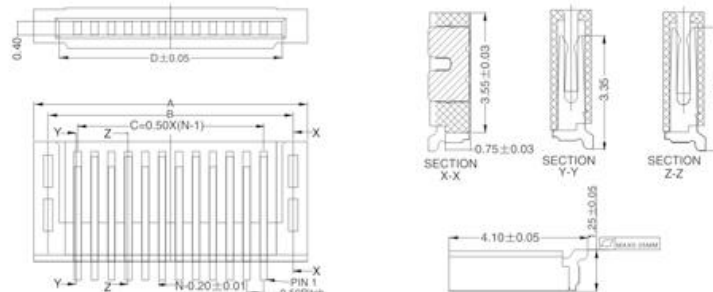

PORT NO	Dimension			PORT NO	Dimension		
	A	B	D		A	B	C
04P	4.10	3.25	2.60	25P	14.60	13.75	13.10
05P	4.60	3.75	3.10	26P	15.10	14.25	13.60
06P	5.10	4.25	3.60	27P	15.60	14.75	14.10
07P	5.60	4.75	4.10	28P	16.10	15.25	14.60
08P	6.10	5.25	4.60	29P	16.60	15.75	15.10
09P	6.60	5.75	5.10	30P	17.10	16.25	15.60
10P	7.10	6.25	5.60	31P	17.60	16.75	16.10
11P	7.60	6.75	6.10	32P	18.10	17.25	16.60
12P	8.10	7.25	6.60	33P	18.60	17.75	17.10
13P	8.60	7.75	7.10	34P	19.10	18.25	17.60
14P	9.10	8.25	7.60	35P	19.60	18.75	18.10
15P	9.60	8.75	8.10	36P	20.10	19.25	18.60
16P	10.10	9.25	8.60	37P	20.60	19.75	19.10
17P	10.60	9.75	9.10	38P	21.10	20.25	19.60
18P	11.10	10.25	9.60	39P	21.60	20.75	20.10
19P	11.60	10.75	10.10	40P	22.10	21.25	20.60
20P	12.10	11.25	10.60	41P	22.60	21.75	21.10
21P	12.60	11.75	11.10	42P	23.10	22.25	21.60
22P	13.10	12.25	11.60	43P	23.60	22.75	22.10
23P	13.60	12.75	12.10	44P	24.10	23.25	22.60
24P	14.10	13.25	12.60	45P	24.60	23.75	23.10

NOTES:

- MATERIAL:**
HOUSING: HIGH-TEMP PLASTIC, UL94V-0;
COVER: HIGH-TEMP PLASTIC, UL94V-0;
CONTACT: COPPER ALLOY;
PEG: COPPER ALLOY;
- PLATING:**
CONTACT: GOLD OR TIN PLATED
ON NICKEL OVERALL
PEG: TIN PLATED ON NICKEL OVERALL
- RATING:**
CURRENT RATING: 0.5A AC/DC
VOLTAGE RATING: 50V AC/DC
TEMPERATURE RANGE: -25~+85D;

FPC 0.5MM XP H=1.2MM SIDE ENTRY TYPE

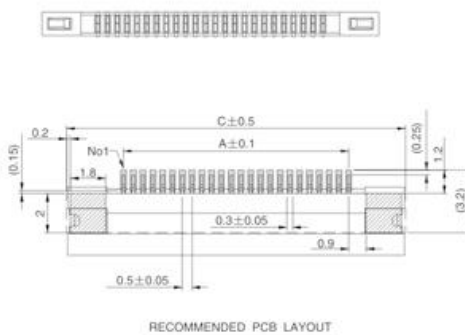
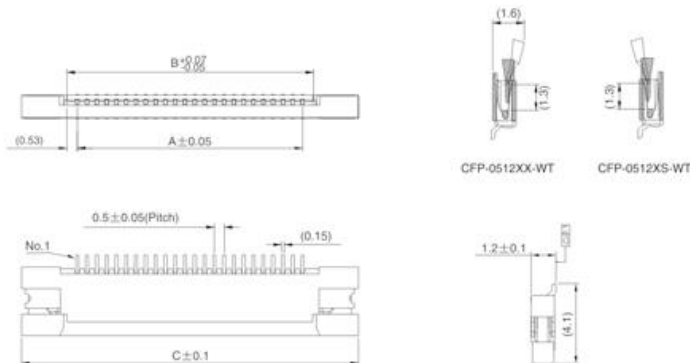

PIN NO	A	B	C	PIN NO	A	B	C
4	1.5	2.56	7.3	21	10	11.06	15.8
5	2	3.06	7.8	22	10.5	11.56	16.3
6	2.5	3.56	8.3	23	11	12.06	16.8
7	3	4.06	8.8	24	11.5	12.56	17.3
8	3.5	4.56	9.3	25	12	13.06	17.8
9	4	5.06	9.8	26	12.5	13.56	18.3
10	4.5	5.56	10.3	27	13	14.06	18.8
11	5	6.06	10.8	28	13.5	14.56	19.3
12	5.5	6.56	11.3	29	14	15.06	19.8
13	6	7.06	11.8	30	14.5	15.56	20.3
14	6.5	7.56	12.3	31	15	16.06	20.8
15	7	8.06	12.8	32	15.5	16.56	21.3
16	7.5	8.56	13.3	33	16	17.06	21.8
17	8	9.06	13.8	34	16.5	17.56	22.3
18	8.5	9.56	14.3	35	17	18.06	22.8
19	9	10.06	14.8	36	17.5	18.56	23.3
20	9.5	10.56	15.3				

Specification:

- Material:**
Housing: High-temp Plastic, UI94v-0,color:natural.
Lock: High-temp Plastic, UI94v-0,color:black.
Contacts: Copper Alloy;
Solder Tab:copper Alloy;
- Electrical Characteristics:**
Current Rating: 0.5a(max)
Voltage Rating: 50v(max)
Operating Temperature: -25C~+85C.
Insulation Resistance:500m Ohms Min. At 500v Dc
Dielectric Withstanding Coltage: 500v Ac/minute.
Contact Resistance:30m Ohms Max.

FPC 0.5MM XP H=1.5MM BACK LOCK

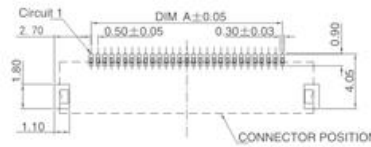
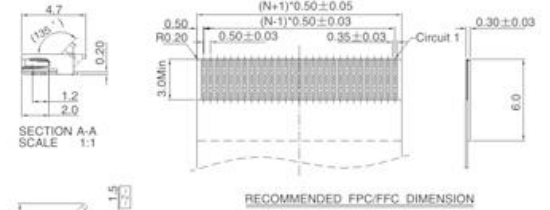
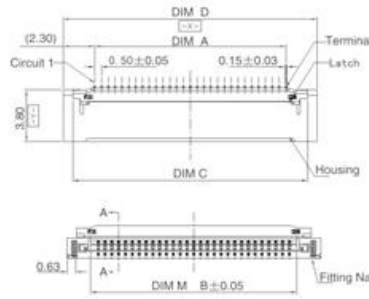

RECOMMENDED P.C.B. PATTERN LAYOUT

PIN NO.	DIM A	DIM B	DIM C	DIM D	32	15.50	16.60	18.70	20.10
04	1.50	2.60	4.70	6.10	35	17.00	18.10	20.20	21.60
05	2.00	3.10	5.20	6.60	36	17.50	18.60	20.70	22.10
06	2.50	3.60	5.70	7.10	37	18.00	19.10	21.20	22.60
07	3.00	4.10	6.20	7.60	38	18.50	19.60	21.70	23.10
08	3.50	4.60	6.70	8.10	39	19.00	20.10	22.20	23.60
09	4.00	5.10	7.20	8.60	40	19.50	20.60	22.70	24.10
10	4.50	5.60	7.70	9.10	41	20.00	21.10	23.20	24.60
11	5.00	6.10	8.20	9.60	42	20.50	21.60	23.70	25.10
12	5.50	6.60	8.70	10.10	43	21.00	22.10	24.20	25.60
13	6.00	7.10	9.20	10.60	44	21.50	22.60	24.70	26.10
14	6.50	7.60	9.70	11.10	45	22.00	23.10	25.20	26.60
15	7.00	8.10	10.20	11.60	46	22.50	23.60	25.70	27.10
16	7.50	8.60	10.70	12.10	47	23.00	24.10	26.20	27.60
17	8.00	9.10	11.20	12.60	48	23.50	24.60	26.70	28.10
18	8.50	9.60	11.70	13.10	49	24.00	25.10	27.20	28.60
19	9.00	10.10	12.20	13.60	50	24.50	25.60	27.70	29.10
20	9.50	10.60	12.70	14.10	51	25.00	26.10	28.20	29.60
21	10.00	11.10	13.20	14.60	52	25.50	26.60	28.70	30.10
22	10.50	11.60	13.70	15.10	53	26.00	27.10	29.20	30.60
23	11.00	12.10	14.20	15.60	54	26.50	27.60	29.70	31.10
24	11.50	12.60	14.70	16.10	55	27.00	28.10	30.20	31.60
25	12.00	13.10	15.20	16.60	56	27.50	28.60	30.70	32.10
26	12.50	13.60	15.70	17.10	57	28.00	29.10	31.20	32.60
27	13.00	14.10	16.20	17.60	58	28.50	29.60	31.70	33.10
28	13.50	14.60	16.70	18.10	59	29.00	30.10	32.20	33.60
29	14.00	15.10	17.20	18.60	60	29.50	30.60	32.70	34.10
30	14.50	15.60	17.70	19.10					
31	15.00	16.10	18.20	19.60					

Note:

1. Material:
 - 1.1 Housing: thermoplastic high temp. UL94V-0; Color: natural.
 - 1.2 Latch: thermoplastic high temp. UL94V-0; Color: black.
 - 1.3 Terminal: copper alloy.
 - 1.4 Fitting Nail: copper alloy.
2. Finish:
 - 2.1 Terminal: Underplating: Au/matt Tin overall.
 - 2.2 Fitting Nail: Underplating: matt Tin overall.
3. Product must comply HF RoHS specification.

FPC 0.5MM XP H=2.0MM PEDAL-LIFT TYPE

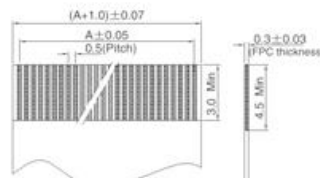
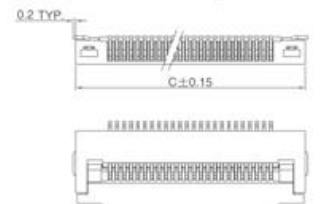
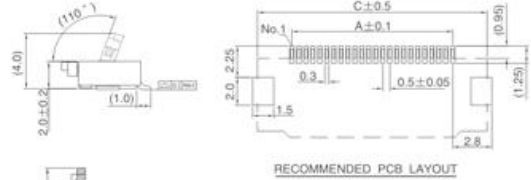
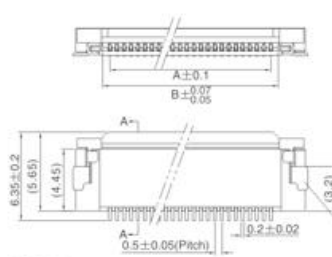

APPLICABLE FPC

SPECIFICATION

1. Material:
 - Housing: HIGH-TEMP Plastic, UL94V-0, color: Natural.
 - Lock: HIGH-TEMP Plastic, UL94V-0, color: black.
 - Contacts: Copper alloy.
 - Solder tab: Copper alloy.
2. Electrical Characteristics:
 - Current rating: 0.5A(max).
 - Voltage rating: 50V(max).
 - Operating Temperature: -25°C~+85°C.
 - Insulation resistance: 500M ohms min. at 500V DC
 - Dielectric withstanding voltage: 500V AC/minute.
 - Contact resistance: 30m ohms max.

PIN NO.	A	B	C	PIN NO.	A	B	C
4	1.5	2.56	6.4	33	16	17.06	20.9
5	2	3.06	6.9	34	16.5	17.56	21.4
6	2.5	3.56	7.4	35	17	18.06	21.9
7	3	4.06	7.9	36	17.5	18.56	22.4
8	3.5	4.56	8.4	37	18	19.06	22.9
9	4	5.06	8.9	38	18.5	19.56	23.4
10	4.5	5.56	9.4	39	19	20.06	23.9
11	5	6.06	9.9	40	19.5	20.56	24.4
12	5.5	6.56	10.4	41	20	21.06	24.9
13	6	7.06	10.9	42	20.5	21.56	25.4
14	6.5	7.56	11.4	43	21	22.06	25.9
15	7	8.06	11.9	44	21.5	22.56	26.4
16	7.5	8.56	12.4	45	22	23.06	26.9
17	8	9.06	12.9	46	22.5	23.56	27.4
18	8.5	9.56	13.4	47	23	24.06	27.9
19	9	10.06	13.9	48	23.5	24.56	28.4
20	9.5	10.56	14.4	49	24	25.06	28.9
21	10	11.06	14.9	50	24.5	25.56	29.4
22	10.5	11.56	15.4	51	25	26.06	29.9
23	11	12.06	15.9	52	25.5	26.56	30.4
24	11.5	12.56	16.4	53	26	27.06	30.9
25	12	13.06	16.9	54	26.5	27.56	31.4
26	12.5	13.56	17.4	55	27	28.06	31.9
27	13	14.06	17.9	56	27.5	28.56	32.4
28	13.5	14.56	18.4	57	28	29.06	32.9
29	14	15.06	18.9	58	28.5	29.56	33.4
30	14.5	15.56	19.4	60	29.5	30.56	34.4
31	15	16.06	19.9	64	31.5	32.56	36.4
32	15.5	16.56	20.4	68	33.5	34.56	38.4
				80	39.5	40.56	44.4

FPC 0.5MM XP H=2.0MM SIDE ENTRY TYPE

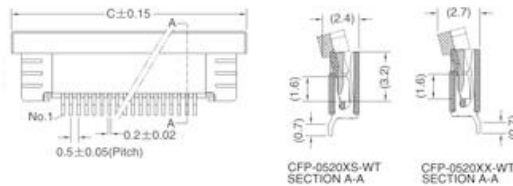
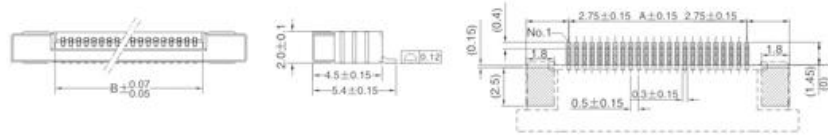

RECOMMENDED PCB LAYOUT

PIN NO.	A	B	C	PIN NO.	A	B	C
4	1.5	2.56	8.2	33	16	17.06	22.7
5	2	3.06	8.7	34	16.5	17.56	23.2
6	2.5	3.56	9.2	35	17	18.06	23.7
7	3	4.06	9.7	36	17.5	18.56	24.2
8	3.5	4.56	10.2	37	18	19.06	24.7
9	4	5.06	10.7	38	18.5	19.56	25.2
10	4.5	5.56	11.2	39	19	20.06	25.7
11	5	6.06	11.7	40	19.5	20.56	26.2
12	5.5	6.56	12.2	41	20	21.06	26.7
13	6	7.06	12.7	42	20.5	21.56	27.2
14	6.5	7.56	13.2	43	21	22.06	27.7
15	7	8.06	13.7	44	21.5	22.56	28.2
16	7.5	8.56	14.2	45	22	23.06	28.7
17	8	9.06	14.7	46	22.5	23.56	29.2
18	8.5	9.56	15.2	47	23	24.06	29.7
19	9	10.06	15.7	48	23.5	24.56	30.2
20	9.5	10.56	16.2	49	24	25.06	30.7
21	10	11.06	16.7	50	24.5	25.56	31.2
22	10.5	11.56	17.2	51	25	26.06	31.7
23	11	12.06	17.7	52	25.5	26.56	32.2
24	11.5	12.56	18.2	53	26	27.06	32.7
25	12	13.06	18.7	54	26.5	27.56	33.2
26	12.5	13.56	19.2	55	27	28.06	33.7
27	13	14.06	19.7	56	27.5	28.56	34.2
28	13.5	14.56	20.2	57	28	29.06	34.7
29	14	15.06	20.7	58	28.5	29.56	35.2
30	14.5	15.56	21.2	59	29	30.06	35.7
31	15	16.06	21.7	60	29.5	30.56	36.2
32	15.5	16.56	22.2				

SPECIFICATION

- Material:**
Housing: HIGH-TEMP Plastic, UL94V-0,color:Natural.
Lock: HIGH-TEMP Plastic, UL94V-0,color:black.
Contacts: Copper alloy.
Solder tab : Copper alloy.
- Electrical Characteristics:**
Current rating : 0.5A(max).
Voltage rating : 50V(max).
Operating Temperature: -25°C~+85°C.
Insulation resistance: 500M ohms min. at 500V DC
Dielectric withstanding voltage:500V AC/minute.
Contact resistance: 30m ohms max.

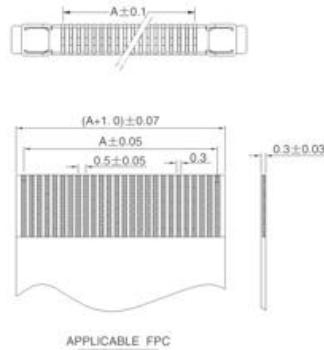

FPC 0.5MM XP VERTICAL ENTRY PEDAL-LIFT TYPE

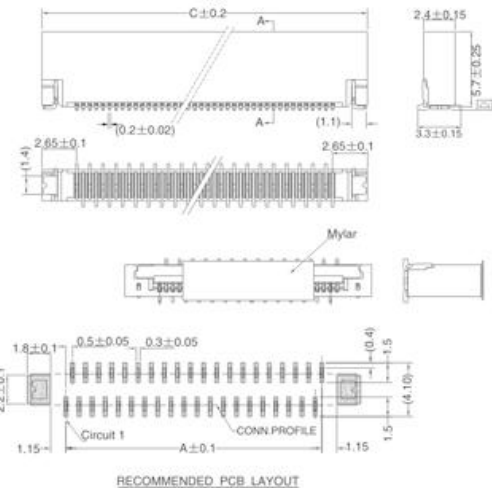
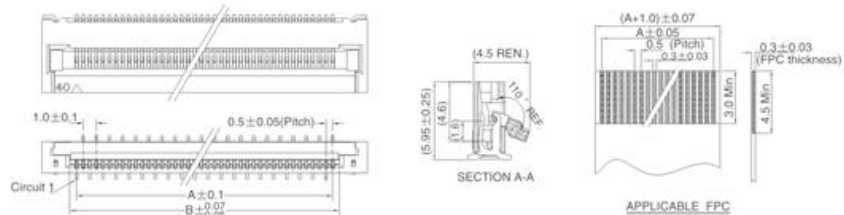

PIN NO.	A	B	C	PIN NO.	A	B	C
4	1.5	2.56	6.8	33	16	17.06	21.3
5	2	3.06	7.3	34	16.5	17.56	21.8
6	2.5	3.56	7.8	35	17	18.06	22.3
7	3	4.06	8.3	36	17.5	18.56	22.8
8	3.5	4.56	8.8	37	18	19.06	23.3
9	4	5.06	9.3	38	18.5	19.56	23.8
10	4.5	5.56	9.8	39	19	20.06	24.3
11	5	6.06	10.3	40	19.5	20.56	24.8
12	5.5	6.56	10.8	41	20	21.06	25.3
13	6	7.06	11.3	42	20.5	21.56	25.8
14	6.5	7.56	11.8	43	21	22.06	26.3
15	7	8.06	12.3	44	21.5	22.56	26.8
16	7.5	8.56	12.8	45	22	23.06	27.3
17	8	9.06	13.3	46	22.5	23.56	27.8
18	8.5	9.56	13.8	47	23	24.06	28.3
19	9	10.06	14.3	48	23.5	24.56	28.8
20	9.5	10.56	14.8	49	24	25.06	29.3
21	10	11.06	15.3	50	24.5	25.56	29.8
22	10.5	11.56	15.8	51	25	26.06	30.3
23	11	12.06	16.3	52	25.5	26.56	30.8
24	11.5	12.56	16.8	53	26	27.06	31.3
25	12	13.06	17.3	54	26.5	27.56	31.8
26	12.5	13.56	17.8	55	27	28.06	32.3
27	13	14.06	18.3	56	27.5	28.56	32.8
28	13.5	14.56	18.8	57	28	29.06	33.3
29	14	15.06	19.3	58	28.5	29.56	33.8
30	14.5	15.56	19.8	59	29	30.06	34.3
31	15	16.06	20.3	60	29.5	30.56	34.8
32	15.5	16.56	20.8				

SPECIFICATION

- Material:**
Housing: HIGH-TEMP Plastic, UL94V-0,color:Natural.
Lock: HIGH-TEMP Plastic, UL94V-0,color:black.
Contacts: Copper alloy.
Solder tab : Copper alloy.
- Electrical Characteristics:**
Current rating : 0.5A(max).
Voltage rating : 50V(max).
Operating Temperature: -25°C~+85°C.
Insulation resistance: 500M ohms min. at 500V DC
Dielectric withstanding voltage:500V AC/minute.
Contact resistance: 30m ohms max.

FPC 0.5MM XP VERTICAL ENTRY TYPE

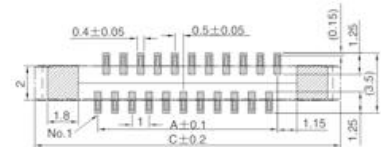
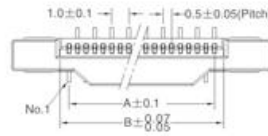

RECOMMENDED PCB LAYOUT

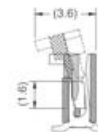
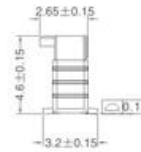
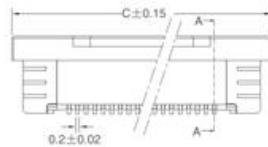

SECTION A-A

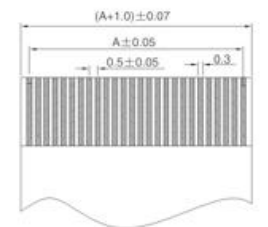

APPLICABLE FPC

PIN NO.	A	B	C	PIN NO.	A	B	C
4	1.5	2.56	8.2	33	16	17.06	22.7
5	2	3.06	8.7	34	16.5	17.56	23.2
6	2.5	3.56	9.2	35	17	18.06	23.7
7	3	4.06	9.7	36	17.5	18.56	24.2
8	3.5	4.56	10.2	37	18	19.06	24.7
9	4	5.06	10.7	38	18.5	19.56	25.2
10	4.5	5.56	11.2	39	19	20.06	25.7
11	5	6.06	11.7	40	19.5	20.56	26.2
12	5.5	6.56	12.2	41	20	21.06	26.7
13	6	7.06	12.7	42	20.5	21.56	27.2
14	6.5	7.56	13.2	43	21	22.06	27.7
15	7	8.06	13.7	44	21.5	22.56	28.2
16	7.5	8.56	14.2	45	22	23.06	28.7
17	8	9.06	14.7	46	22.5	23.56	29.2
18	8.5	9.56	15.2	47	23	24.06	29.7
19	9	10.06	15.7	48	23.5	24.56	30.2
20	9.5	10.56	16.2	49	24	25.06	30.7
21	10	11.06	16.7	50	24.5	25.56	31.2
22	10.5	11.56	17.2	51	25	26.06	31.7
23	11	12.06	17.7	52	25.5	26.56	32.2
24	11.5	12.56	18.2	53	26	27.06	32.7
25	12	13.06	18.7	54	26.5	27.56	33.2
26	12.5	13.56	19.2	55	27	28.06	33.7
27	13	14.06	19.7	56	27.5	28.56	34.2
28	13.5	14.56	20.2	57	28	29.06	34.7
29	14	15.06	20.7	58	28.5	29.56	35.2
30	14.5	15.56	21.2	59	29	30.06	35.7
31	15	16.06	21.7	60	29.5	30.56	36.2
32	15.5	16.56	22.2				

SPECIFICATION

- Material:
 - Housing: HIGH-TEMP Plastic, UL94V-0,color:Natural.
 - Lock: HIGH-TEMP Plastic, UL94V-0,color:black.
 - Contacts: Copper alloy.
 - Solder tab : Copper alloy.
- Electrical Characteristics:
 - Current rating : 0.5A(max).
 - Voltage rating : 50V(max).
 - Operating Temperature: -25°C~+85°C.
 - Insulation resistance: 500M ohms min. at 500V DC
 - Dielectric withstanding voltage:500V AC/minute.
 - Contact resistance: 30m ohms max.

FPC 0.5MM XP H=2.7MM BACK LOCK

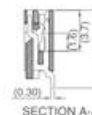
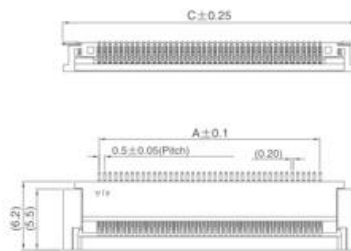
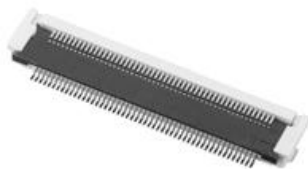

SECTION A-A

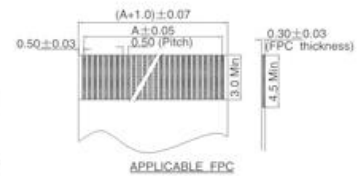

APPLICABLE FPC



PIN NO.	A	B	C	PIN NO.	A	B	C
4	1.5	2.56	8.5	33	16	17.06	23
5	2	3.06	9	34	16.5	17.56	23.5
6	2.5	3.56	9.5	35	17	18.06	24
7	3	4.06	10	36	17.5	18.56	24.5
8	3.5	4.56	10.5	37	18	19.06	25
9	4	5.06	11	38	18.5	19.56	25.5
10	4.5	5.56	11.5	39	19	20.06	26
11	5	6.06	12	40	19.5	20.56	26.5
12	5.5	6.56	12.5	41	20	21.06	27
13	6	7.06	13	42	20.5	21.56	27.5
14	6.5	7.56	13.5	43	21	22.06	28
15	7	8.06	14	44	21.5	22.56	28.5
16	7.5	8.56	14.5	45	22	23.06	29
17	8	9.06	15	46	22.5	23.56	29.5
18	8.5	9.56	15.5	47	23	24.06	30
19	9	10.06	16	48	23.5	24.56	30.5
20	9.5	10.56	16.5	49	24	25.06	31
21	10	11.06	17	50	24.5	25.56	31.5
22	10.5	11.56	17.5	51	25	26.06	32
23	11	12.06	18	52	25.5	26.56	32.5
24	11.5	12.56	18.5	53	26	27.06	33
25	12	13.06	19	54	26.5	27.56	33.5
26	12.5	13.56	19.5	55	27	28.06	34
27	13	14.06	20	56	27.5	28.56	34.5
28	13.5	14.56	20.5	57	28	29.06	35
29	14	15.06	21	58	28.5	29.56	35.5
30	14.5	15.56	21.5	60	29.5	31.56	36.50
31	15	16.06	22	64	31.5	32.56	35.5
32	15.5	16.56	22.5	80	39.5	40.56	46.5

SPECIFICATION

- Material:
 - Housing: HIGH-TEMP Plastic, UL94V-0,color:Natural.
 - Lock: HIGH-TEMP Plastic, UL94V-0,color:black.
 - Contacts: Copper alloy.
 - Solder tab : Copper alloy.
- Electrical Characteristics:
 - Current rating : 0.5A(max).
 - Voltage rating : 50V(max).
 - Operating Temperature: -25°C~+85°C.
 - Insulation resistance: 500M ohms min. at 500V DC
 - Dielectric withstanding voltage:500V AC/minute.
 - Contact resistance: 30m ohms max.

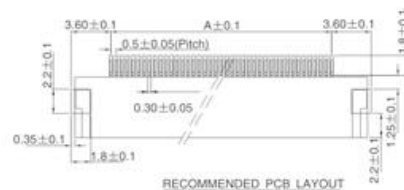

RECOMMENDED PCB LAYOUT

FPC 0.8MM XP H=2.0MM PEDAL-LIFT TYPE

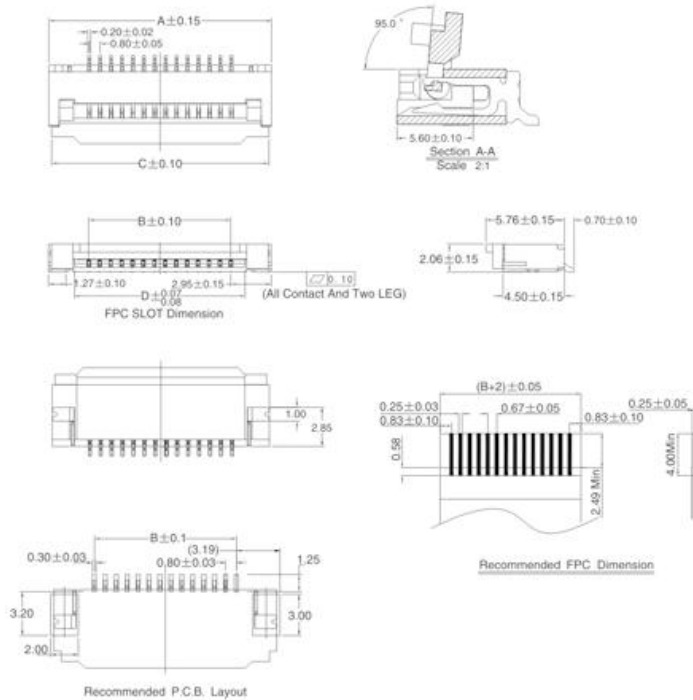

CKT	Dimension			
	A	B	C	D
04	8.30	2.40	7.90	4.50
05	9.10	3.20	8.70	5.30
06	9.90	4.00	9.50	6.10
07	10.70	4.80	10.30	6.90
08	11.50	5.60	11.10	7.70
09	12.30	6.40	11.90	8.50
10	13.10	7.20	12.70	9.30
11	13.90	8.00	13.50	10.10
12	14.70	8.80	14.30	10.90
13	15.50	9.60	15.10	11.70
14	16.30	10.40	15.90	12.50
15	17.10	11.20	16.70	13.30
16	17.90	12.00	17.50	14.10
17	18.70	12.80	18.30	14.90
18	19.50	13.60	19.10	15.70
19	20.30	14.40	19.90	16.50
20	21.10	15.20	20.70	17.30
21	21.90	16.00	21.50	18.10
22	22.70	16.80	22.30	18.90
23	23.50	17.60	23.10	19.70
24	24.30	18.40	23.90	20.50
25	25.10	19.20	24.70	21.30
26	25.90	20.00	25.50	22.10
27	26.70	20.80	26.30	22.90
28	27.50	21.60	27.10	23.70
29	28.30	22.40	27.90	24.50
30	29.10	23.20	28.70	25.30
31	29.90	24.00	29.50	26.10
32	30.70	24.80	30.30	26.90
33	31.50	25.60	31.10	27.70
34	32.30	26.40	31.90	28.50
35	33.10	27.20	32.70	29.30
36	33.90	28.00	33.50	30.10
37	34.70	28.80	34.30	30.90
38	35.50	29.60	35.10	31.70
39	36.30	30.40	35.90	32.50
40	37.10	31.20	36.70	33.30

NOTES:

- Material:
 - Housing: HIGH-TEMP Plastic, UL94V-0;
 - Lock: HIGH-TEMP Plastic, UL94V-0;
 - Contacts: Copper alloy.
 - Peg: Copper alloy.
- Plating:
 - Contact: Gold or tin plated on nickel overall.
 - Peg: Tin plated on nickel overall.
- Rating:
 - Current rating : 0.5A AC/DC
 - Voltage rating : 50V AC/DC
 - Temperature range:-25D~+85D.

FPC 0.8MM XP H=2.0MM SIDE ENTRY TYPE

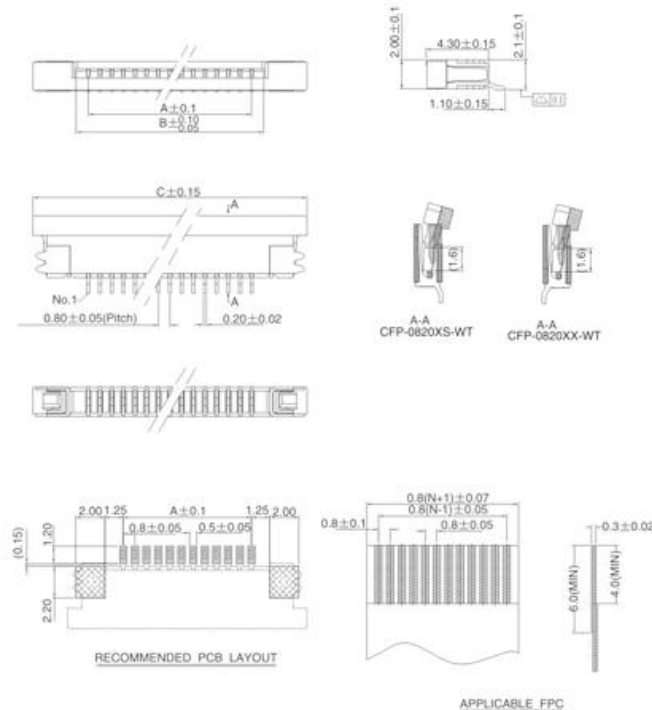

PIN NO.	A	B	C
4	2.4	4	10.0
5	3.2	4.8	10.8
6	4	5.6	11.6
7	4.8	6.4	12.4
8	5.6	7.2	13.2
9	6.4	8	14.0
10	7.2	8.8	14.8
11	8	9.6	15.6
12	8.8	10.4	16.4
13	9.6	11.2	17.2
14	10.4	12	18.0
15	11.2	12.8	18.8
16	12	13.6	19.6
17	12.8	14.4	20.4
18	13.6	15.2	21.2
19	14.4	16	22.0
20	15.2	16.8	22.8
21	16	17.6	23.6
22	16.8	18.4	24.4
23	17.6	19.2	25.2
24	18.4	20	26.0
25	19.2	20.8	26.8
26	20	21.6	27.6
27	20.8	22.4	28.4
28	21.6	23.2	29.2
29	22.4	24	30.0
30	23.2	24.8	30.8
31	24	25.6	31.6
32	24.8	26.4	32.4
33	25.6	27.2	33.2
34	26.4	28	34.0
35	27.2	28.8	34.8
36	28	29.6	35.6
37	28.8	30.4	36.4
38	29.6	31.2	37.2
39	30.4	32	38.0
40	31.2	32.8	38.8

SPECIFICATION

- Material:
 - Housing: HIGH-TEMP Plastic, UL94V-0,color:Natural.
 - Lock: HIGH-TEMP Plastic, UL94V-0,color:black.
 - Contacts: Copper alloy.
 - Solder tab : Copper alloy.
- Electrical Characteristics:
 - Current rating : 0.5A(max).
 - Voltage rating : 50V(max).
 - Operating Temperature: -25°C~+85°C.
 - Insulation resistance: 500M ohms min. at 500V DC
 - Dielectric withstanding voltage:500V AC/minute.
 - Contact resistance: 30m ohms max.

FPC 1.0MM XP H=1.5MM PEDAL-LIFT TYPE

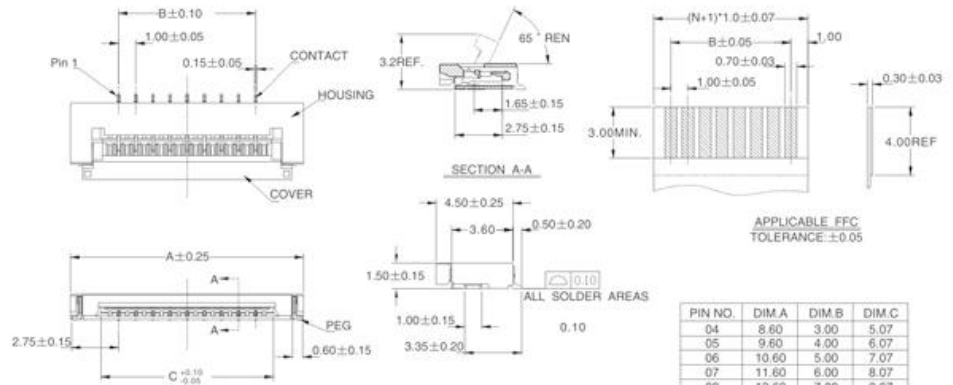

APPLICABLE FPC
TOLERANCE ±0.05

PIN NO.	DIM A	DIM B	DIM C
04	8.60	3.00	5.07
05	9.60	4.00	6.07
06	10.60	5.00	7.07
07	11.60	6.00	8.07
08	12.60	7.00	9.07
09	13.60	8.00	10.07
10	14.60	9.00	11.07
11	15.60	10.00	12.07
12	16.60	11.00	13.07
13	17.60	12.00	14.07
14	18.60	13.00	15.07
15	19.60	14.00	16.07
16	20.60	15.00	17.07
17	21.60	16.00	18.07
18	22.60	17.00	19.07
19	23.60	18.00	20.07
20	24.60	19.00	21.07
21	25.60	20.00	22.07
22	26.60	21.00	23.07
23	27.60	22.00	24.07
24	28.60	23.00	25.07
25	29.60	24.00	26.07
26	30.60	25.00	27.07
27	31.60	26.00	28.07
28	32.60	27.00	29.07
29	33.60	28.00	30.07
30	34.60	29.00	31.07
31	35.60	30.00	32.07
32	36.60	31.00	33.07
33	37.60	32.00	34.07

SPECIFICATION

1. Material:

Housing: HIGH-TEMP Plastic, UL94V-0,color:Natural.

Lock: HIGH-TEMP Plastic, UL94V-0,color:black.

Contacts: Copper alloy.

Solder tab : Copper alloy.

2. Electrical Characteristics:

Current rating : 0.5A(max).

Voltage rating : 50V(max).

Operating Temperature: -25°C~+85°C.

Insulation resistance: 500M ohms min. at 500V DC

Dielectric withstanding voltage:500V AC/minute.

Contact resistance: 30m ohms max.

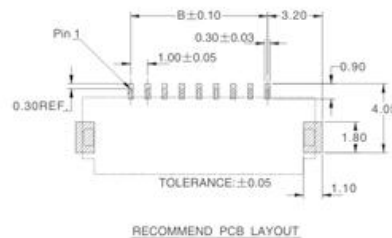

RECOMMEND PCB LAYOUT

FPC 1.0MM XP H=2.0MM PEDAL-LIFT TYPE

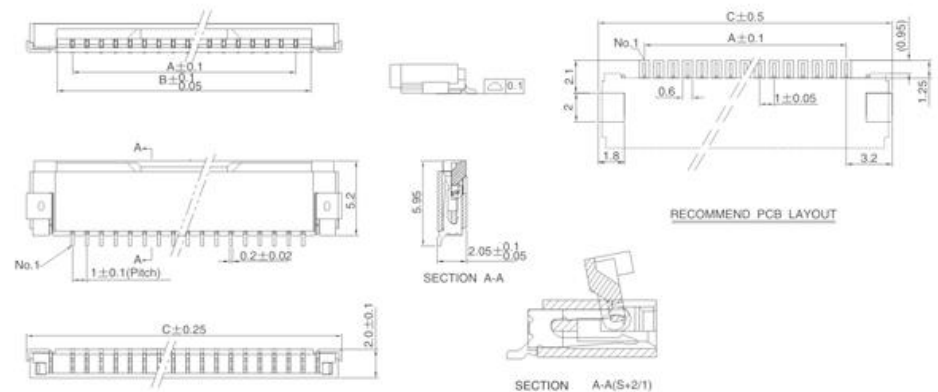

RECOMMEND PCB LAYOUT

SECTION A-A(S+2/1)

PIN NO.	A	B	C	PIN NO.	A	B	C
2	1	3.1	7.4	18	17	19.1	23.4
3	2	4.1	8.4	19	18	20.1	24.4
4	3	5.1	9.4	20	19	21.1	25.4
5	4	6.1	10.4	21	20	22.1	26.4
6	5	7.1	11.4	22	21	23.1	27.4
7	6	8.1	12.4	23	22	24.1	28.4
8	7	9.1	13.4	24	23	25.1	29.4
9	8	10.1	14.4	25	24	26.1	30.4
10	9	11.1	15.4	26	25	27.1	31.4
11	10	12.1	16.4	27	26	28.1	32.4
12	11	13.1	17.4	28	27	29.1	33.4
13	12	14.1	18.4	29	28	30.1	34.4
14	13	15.1	19.4	30	29	31.1	35.4
15	14	16.1	20.4	32	31	33.06	37.4
16	15	17.1	21.4	39	38	40.06	44.4
17	16	18.1	22.4				

SPECIFICATION

1. Material:

Housing: HIGH-TEMP Plastic, UL94V-0,color:Natural.

Lock: HIGH-TEMP Plastic, UL94V-0,color:black.

Contacts: Copper alloy.

Solder tab : Copper alloy.

2. Electrical Characteristics:

Current rating : 0.5A(max).

Voltage rating : 50V(max).

Operating Temperature: -25°C~+85°C.

Insulation resistance: 500M ohms min. at 500V DC

Dielectric withstanding voltage:500V AC/minute.

Contact resistance: 30m ohms max.

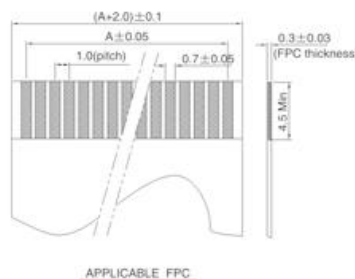

APPLICABLE FPC

FPC 1.0MM XP H=2.5MM SMT SIDE ENTRY TYPE

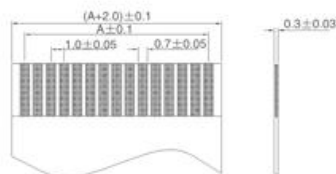
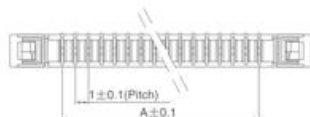
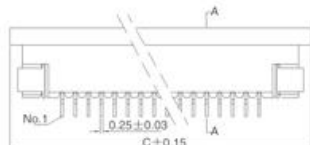

APPLICABLE FPC

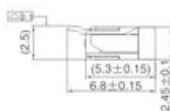
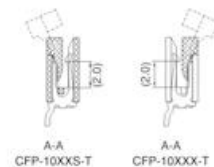

PIN NO.	A	B	C	PIN NO.	A	B	C
4	3	5.06	11	23	22	24.06	30
5	4	6.06	12	24	23	25.06	31
6	5	7.06	13	25	24	26.06	32
7	6	8.06	14	26	25	27.06	33
8	7	9.06	15	27	26	28.06	34
9	8	10.06	16	28	27	29.06	35
10	9	11.06	17	29	28	30.06	36
11	10	12.06	18	30	29	31.06	37
12	11	13.06	19	31	30	32.06	38
13	12	14.06	20	32	31	33.06	39
14	13	15.06	21	33	32	34.06	40
15	14	16.06	22	34	33	35.06	41
16	15	17.06	23	35	34	36.06	42
17	16	18.06	24	36	35	37.06	43
18	17	19.06	25	37	36	38.06	44
19	18	20.06	26	38	37	39.06	45
20	19	21.06	27	39	38	40.06	46
21	20	22.06	28	40	39	41.06	47
22	21	23.06	29				

SPECIFICATION

1. Material:

- Housing: HIGH-TEMP Plastic, UL94V-0,color:Natural.
- Lock: HIGH-TEMP Plastic, UL94V-0,color:black.
- Contacts: Copper alloy.
- Solder tab : Copper alloy.

2. Electrical Characteristics:

- Current rating : 0.5A(max).
- Voltage rating : 50V(max).
- Operating Temperature: -25°C~+85°C.
- Insulation resistance: 500M ohms min. at 500V DC
- Dielectric withstanding voltage:500V AC/minute.
- Contact resistance: 30m ohms max.

FPC 1.0MM XP SMT VERTICAL ENTRY TYPE

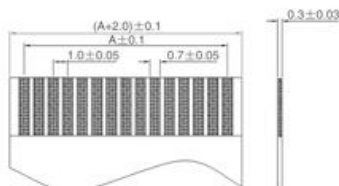
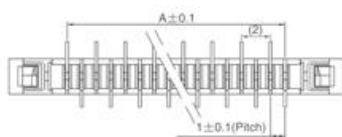
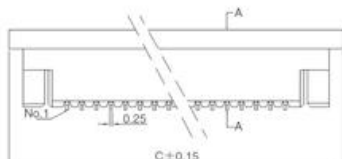
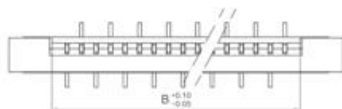

APPLICABLE FPC

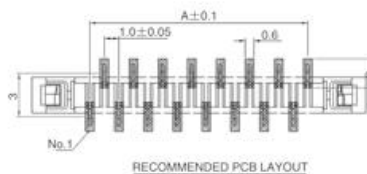
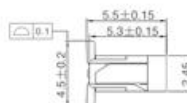
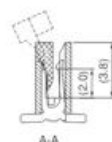

PIN NO.	A	B	C	PIN NO.	A	B	C
4	3	5.06	11	23	22	24.06	30
5	4	6.06	12	24	23	25.06	31
6	5	7.06	13	25	24	26.06	32
7	6	8.06	14	26	25	27.06	33
8	7	9.06	15	27	26	28.06	34
9	8	10.06	16	28	27	29.06	35
10	9	11.06	17	29	28	30.06	36
11	10	12.06	18	30	29	31.06	37
12	11	13.06	19	31	30	32.06	38
13	12	14.06	20	32	31	33.06	39
14	13	15.06	21	33	32	34.06	40
15	14	16.06	22	34	33	35.06	41
16	15	17.06	23	35	34	36.06	42
17	16	18.06	24	36	35	37.06	43
18	17	19.06	25	37	36	38.06	44
19	18	20.06	26	38	37	39.06	45
20	19	21.06	27	39	38	40.06	46
21	20	22.06	28	40	39	41.06	47
22	21	23.06	29				

SPECIFICATION

1. Material:

- Housing: HIGH-TEMP Plastic, UL94V-0,color:Natural.
- Lock: HIGH-TEMP Plastic, UL94V-0,color:black.
- Contacts: Copper alloy.

2. Electrical Characteristics:

- Current rating : 0.5A(max).
- Voltage rating : 50V(max).
- Operating Temperature: -25°C~+85°C.
- Insulation resistance: 500M ohms min. at 500V DC
- Dielectric withstanding voltage:500V AC/minute.
- Contact resistance: 30m ohms max.

FPC 1.0MM XP DIP90 WITH LOCK

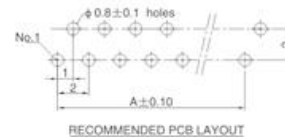
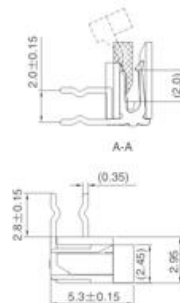
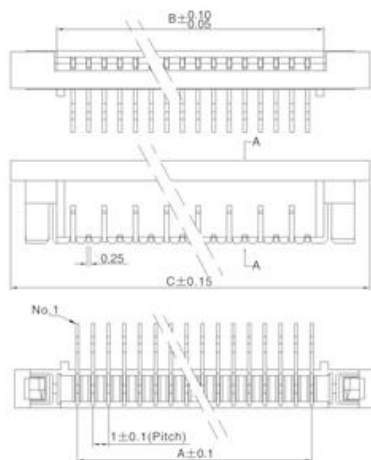

PIN NO.	A	B	C	PIN NO.	A	B	C
4	3	5.06	11	23	22	24.06	30
5	4	6.06	12	24	23	25.06	31
6	5	7.06	13	25	24	26.06	32
7	6	8.06	14	26	25	27.06	33
8	7	9.06	15	27	26	28.06	34
9	8	10.06	16	28	27	29.06	35
10	9	11.06	17	29	28	30.06	36
11	10	12.06	18	30	29	31.06	37
12	11	13.06	19	31	30	32.06	38
13	12	14.06	20	32	31	33.06	39
14	13	15.06	21	33	32	34.06	40
15	14	16.06	22	34	33	35.06	41
16	15	17.06	23	35	34	36.06	42
17	16	18.06	24	36	35	37.06	43
18	17	19.06	25	37	36	38.06	44
19	18	20.06	26	38	37	39.06	45
20	19	21.06	27	39	38	40.06	46
21	20	22.06	28	40	39	41.06	47
22	21	23.06	29				

SPECIFICATION

- Material:**
Housing: HIGH-TEMP Plastic, UL94V-0,color:Natural.
Lock: HIGH-TEMP Plastic, UL94V-0,color:black.
Contacts: Copper alloy.
- Electrical Characteristics:**
Current rating : 0.5A(max).
Voltage rating : 50V(max).
Operating Temperature: -25°C~+85°C.
Insulation resistance: 500M ohms min. at 500V DC
Dielectric withstanding voltage:500V AC/minute.
Contact resistance: 30m ohms max.

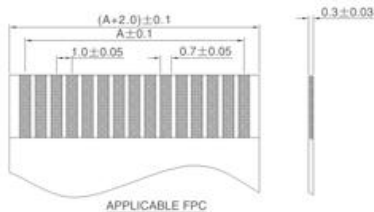

FPC 1.0MM XP DIP180 WITH LOCK

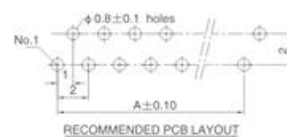
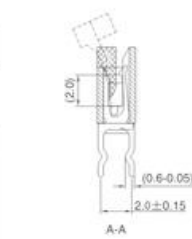
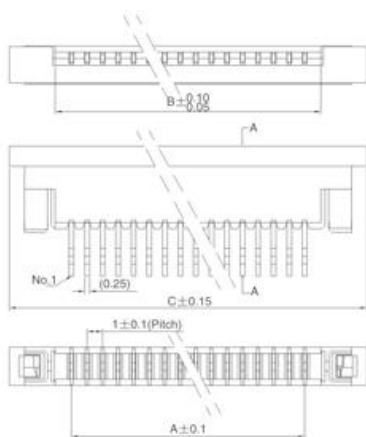

PIN NO.	A	B	C	PIN NO.	A	B	C
4	3	5.06	11	23	22	24.06	30
5	4	6.06	12	24	23	25.06	31
6	5	7.06	13	25	24	26.06	32
7	6	8.06	14	26	25	27.06	33
8	7	9.06	15	27	26	28.06	34
9	8	10.06	16	28	27	29.06	35
10	9	11.06	17	29	28	30.06	36
11	10	12.06	18	30	29	31.06	37
12	11	13.06	19	31	30	32.06	38
13	12	14.06	20	32	31	33.06	39
14	13	15.06	21	33	32	34.06	40
15	14	16.06	22	34	33	35.06	41
16	15	17.06	23	35	34	36.06	42
17	16	18.06	24	36	35	37.06	43
18	17	19.06	25	37	36	38.06	44
19	18	20.06	26	38	37	39.06	45
20	19	21.06	27	39	38	40.06	46
21	20	22.06	28	40	39	41.06	47
22	21	23.06	29				

SPECIFICATION

- Material:**
Housing: HIGH-TEMP Plastic, UL94V-0,color:Natural.
Lock: HIGH-TEMP Plastic, UL94V-0,color:black.
Contacts: Copper alloy.
- Electrical Characteristics:**
Current rating : 0.5A(max).
Voltage rating : 50V(max).
Operating Temperature: -25°C~+85°C.
Insulation resistance: 500M ohms min. at 500V DC
Dielectric withstanding voltage:500V AC/minute.
Contact resistance: 30m ohms max.

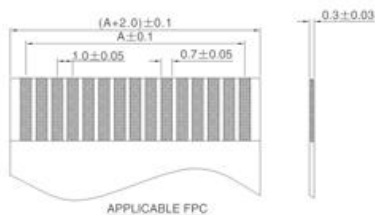

FPC 1.0MM XP SMT WITHOUT LOCK

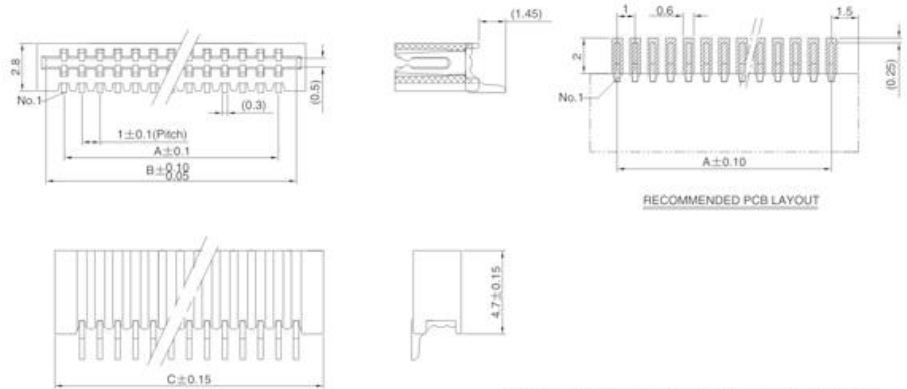

SPECIFICATION

- Material:
 - Housing: HIGH-TEMP Plastic, UL94V-0,color:Natural.
 - Lock: HIGH-TEMP Plastic, UL94V-0,color:black.
 - Contacts: Copper alloy.
- Electrical Characteristics:
 - Current rating : 0.5A(max).
 - Voltage rating : 50V(max).
 - Operating Temperature: -25°C~+85°C.
 - Insulation resistance: 500M ohms min. at 500V DC
 - Dielectric withstanding voltage:500V AC/minute.
 - Contact resistance: 30m ohms max.

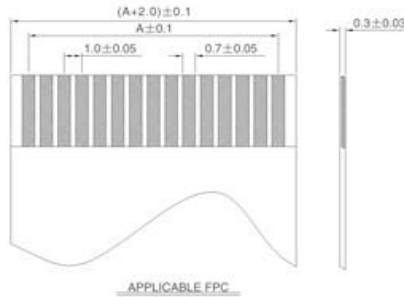

PIN NO	A	B	C	PIN NO	A	B	C
4	3	5.06	6	24	23	25.06	26
5	4	6.06	7	25	24	26.06	27
6	5	7.06	8	26	25	27.06	28
7	6	8.06	9	27	26	28.06	29
8	7	9.06	10	28	27	29.06	30
9	8	10.06	11	29	28	30.06	31
10	9	11.06	12	30	29	31.06	32
11	10	12.06	13	31	30	32.06	33
12	11	13.06	14	32	31	33.06	34
13	12	14.06	15	33	32	34.06	35
14	13	15.06	16	34	33	35.06	36
15	14	16.06	17	35	34	36.06	37
16	15	17.06	18	36	35	37.06	38
17	16	18.06	19	37	36	38.06	39
18	17	19.06	20	38	37	39.06	40
19	18	20.06	21	39	38	40.06	41
20	19	21.06	22	40	39	41.06	42
21	20	22.06	23				
22	21	23.06	24				
23	22	24.06	25				

FPC 1.0MM XP DIP180 WITHOUT LOCK

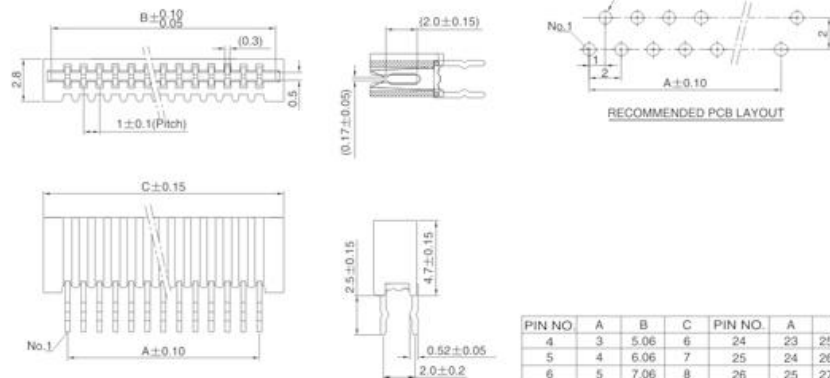

SPECIFICATION

- Material:
 - Housing: HIGH-TEMP Plastic, UL94V-0,color:Natural.
 - Lock: HIGH-TEMP Plastic, UL94V-0,color:black.
 - Contacts: Copper alloy.
- Electrical Characteristics:
 - Current rating : 0.5A(max).
 - Voltage rating : 50V(max).
 - Operating Temperature: -25°C~+85°C.
 - Insulation resistance: 500M ohms min. at 500V DC
 - Dielectric withstanding voltage:500V AC/minute.
 - Contact resistance: 30m ohms max.

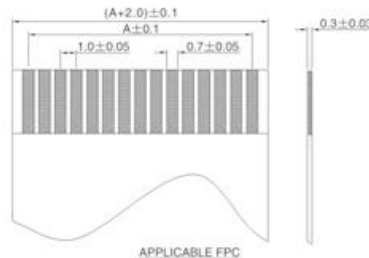

PIN NO	A	B	C	PIN NO	A	B	C
4	3	5.06	6	24	23	25.06	26
5	4	6.06	7	25	24	26.06	27
6	5	7.06	8	26	25	27.06	28
7	6	8.06	9	27	26	28.06	29
8	7	9.06	10	28	27	29.06	30
9	8	10.06	11	29	28	30.06	31
10	9	11.06	12	30	29	31.06	32
11	10	12.06	13	31	30	32.06	33
12	11	13.06	14	32	31	33.06	34
13	12	14.06	15	33	32	34.06	35
14	13	15.06	16	34	33	35.06	36
15	14	16.06	17	35	34	36.06	37
16	15	17.06	18	36	35	37.06	38
17	16	18.06	19	37	36	38.06	39
18	17	19.06	20	38	37	39.06	40
19	18	20.06	21	39	38	40.06	41
20	19	21.06	22	40	39	41.06	42
21	20	22.06	23				
22	21	23.06	24				
23	22	24.06	25				

BTB 0.4MM XP MALE H=0.8MM

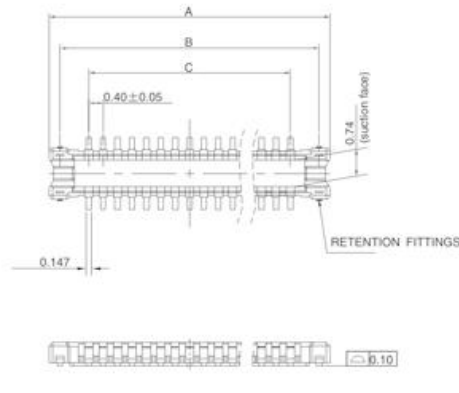

NOTE:

1. MATERIAL:

HOUSING: HIGHT-TEMP PLASTIC UL 94V-0;
CONTACT: COPPER ALLOY;
PEG: COPPER ALLOY;

2. PLATING:

CONTACT: GOLD OR TIN PLATED ON NICKEL OVERALL,
PEG: TIN PLATED ON NICKEL OVERALL.

3. RATING:

CURRENT RATING: 0.3A AC/DDC
VOLTAGE RATING: 60V AD/DC
TEMPERATURE RANGE: -25~+85D.

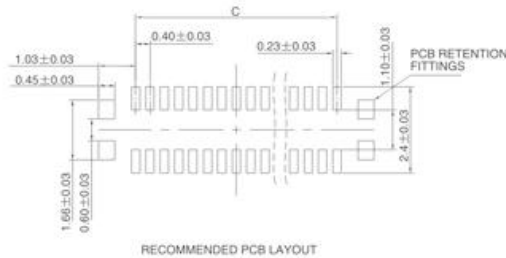
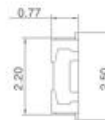
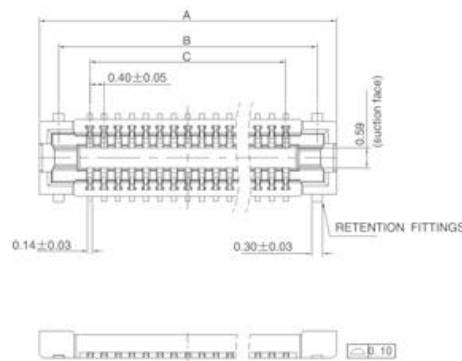

TABLE:

NUMBER OF CONTACTS	A	B	C
70	15.80	15.20	13.60
50	11.80	11.20	9.60
40	9.80	9.20	7.60
34	8.60	8.00	6.40
30	7.80	7.20	5.60
24	6.60	6.00	4.40
10	3.80	3.20	1.60

BTB 0.4MM XP FEMALE H=0.8MM



NOTE:

1. MATERIAL:

HOUSING: HIGHT-TEMP PLASTIC UL 94V-0;
CONTACT: COPPER ALLOY;
PEG: COPPER ALLOY;

2. PLATING:

CONTACT: GOLD OR TIN PLATED ON NICKEL OVERALL,
PEG: TIN PLATED ON NICKEL OVERALL.

3. RATING:

CURRENT RATING: 0.3A AC/DDC
VOLTAGE RATING: 60V AD/DC
TEMPERATURE RANGE: -25~+85D.

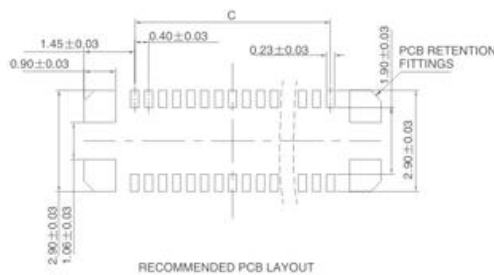
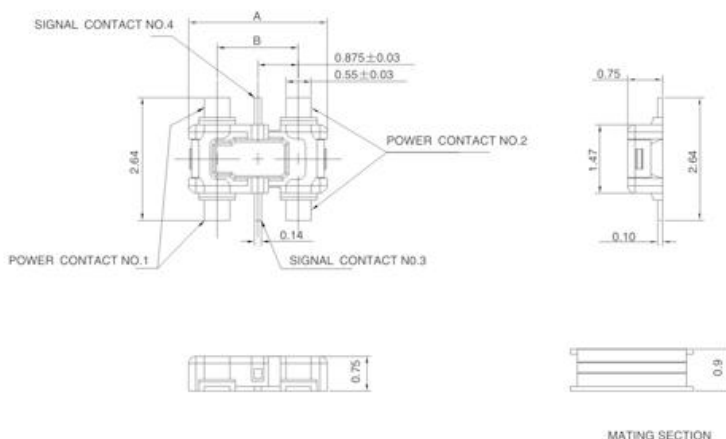

TABLE:

NUMBER OF CONTACTS	A	B	C
70	16.50	15.40	13.60
50	12.50	11.40	9.60
40	10.50	9.40	7.60
34	9.30	8.20	6.40
30	8.50	7.40	5.60
24	7.30	6.20	4.40
10	4.50	3.40	1.60

BTB 0.4MM XP MALE H=0.9MM 4-6P



NOTE:

1.MATERIAL:

HOUSING: HIGHT-TEMP PLASTIC UL 94V-0;

CONTACT: COPPER ALLOY;

PEG: COPPER ALLOY;

2.PLATING:

CONTACT:GOLD OR TIN PLATED ON NICKEL OVERALL.

PEG: TIN PLATED ON NICKEL OVERALL.

3.RATING:

CURRENT RATING:4.0A AC/DDC

VOLTAGE RATING:30V AD/DC

TEMPERTURE RANGE:-25~+85D.

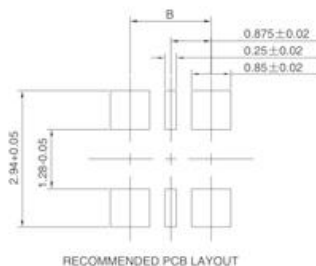
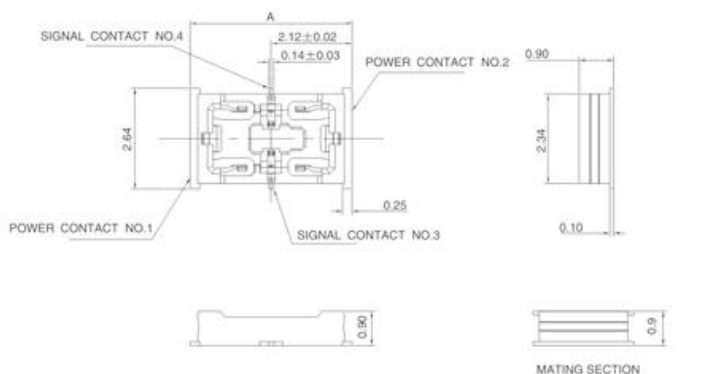

TABLE:

6	3.40	2.15
4	3.00	1.75
NUMBER OF CONTACTS	A	B

BTB 0.4MM XP FEMALE H=0.9MM 4-6P



NOTE:

1.MATERIAL:

HOUSING: HIGHT-TEMP PLASTIC UL 94V-0;

CONTACT: COPPER ALLOY;

PEG: COPPER ALLOY;

2.PLATING:

CONTACT:GOLD OR TIN PLATED ON NICKEL OVERALL.

PEG: TIN PLATED ON NICKEL OVERALL.

3.RATING:

CURRENT RATING:4.0A AC/DDC

VOLTAGE RATING:30V AD/DC

TEMPERTURE RANGE:-25~+85D.

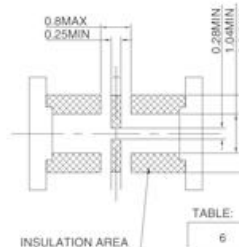
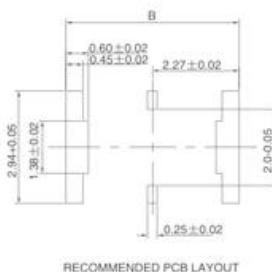
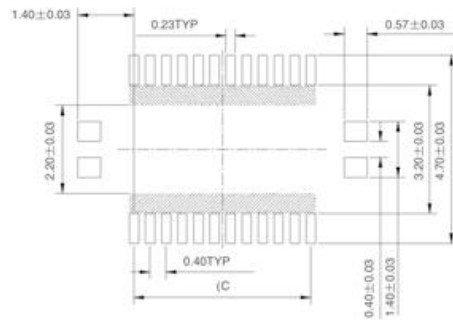
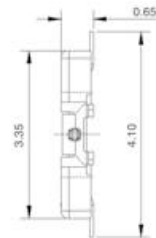
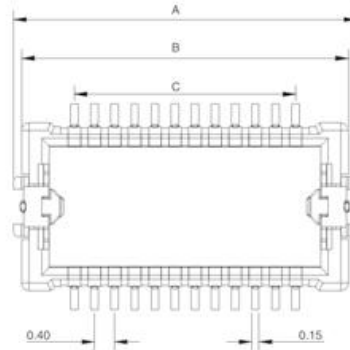

TABLE:

6	4.64	4.94
4	4.24	4.54
NUMBER OF CONTACTS	A	B

BTB 0.4MM XP MALE H=0.9MM



PIN NO.	A	B	C
10	4.00	3.74	1.60
24	6.80	6.54	4.40
30	8.00	7.74	5.60
40	10.00	9.74	7.60
50	12.00	11.74	9.60
60	14.00	13.74	11.60

NOTE:

1. MATERIAL:

HOUSING: HIGHT-TEMP PLASTIC UL 94V-0;
CONTACT: COPPER ALLOY;
PEG: COPPER ALLOY;

2. PLATING:

CONTACT: GOLD OR TIN PLATED ON NICKEL OVERALL.
PEG: TIN PLATED ON NICKEL OVERALL.

3. RATING:

CURRENT RATING: 0.3A AC/DDC
VOLTAGE RATING: 50V AD/DC
TEMPERTURE RANGE: -25~+85D.

RECOMMENO PCB LAYOUT
DEFAULT TOL: ±0.05

BTB 0.4MM XP FEMALE H=0.9MM

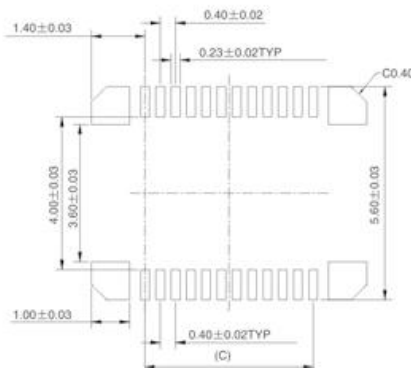
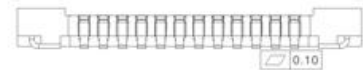
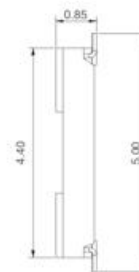
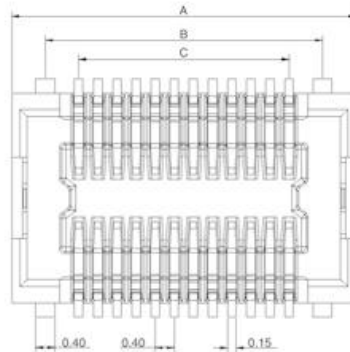

PIN NO.	A	B	C
10	4.40	3.00	1.60
24	7.20	5.80	4.40
30	8.40	7.00	5.60
40	10.40	9.00	7.60
50	12.40	11.00	9.60
60	14.40	13.00	11.60

NOTE:

1. MATERIAL:

HOUSING: HIGHT-TEMP PLASTIC UL 94V-0;
CONTACT: COPPER ALLOY;
PEG: COPPER ALLOY;

2. PLATING:

CONTACT: GOLD OR TIN PLATED ON NICKEL OVERALL.
PEG: TIN PLATED ON NICKEL OVERALL.

3. RATING:

CURRENT RATING: 0.3A AC/DDC
VOLTAGE RATING: 50V AD/DC
TEMPERTURE RANGE: -25~+85D.

RECOMMENO PCB LAYOUT
DEFAULT TOL: ±0.05

BTB 0.4MM XP MALE H=1.5MM

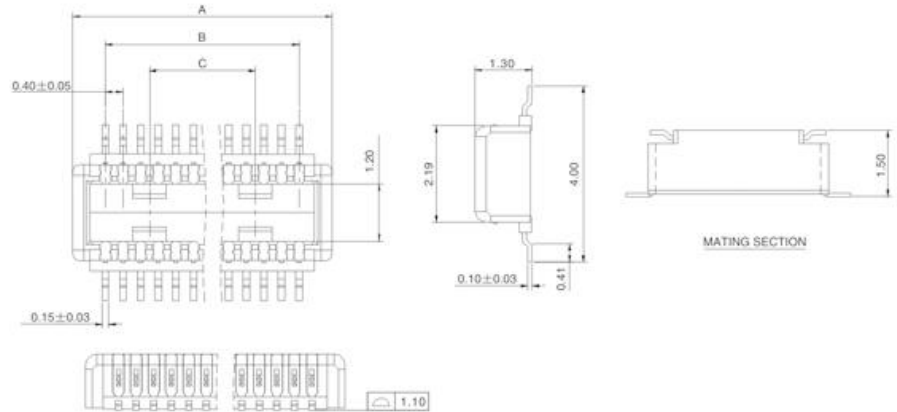

NOTE:

- 1.MATERIAL:
HOUSING: HIGHT-TEMP PLASTIC(WITHOUT HALOGEN)
UL 94V-0;
CONTACT: COPPER ALLOY;
- 2.PLATING:
CONTACT:GOLD OR TIN PLATED
ON N CKEL OVERALL.
- 3.RATING:
VOLTAGE RATING:100V AD/DC
TEMPERTURE RANGE:-25~+85D.

TABLE:

PIN NO.	A	B	C
24	5.90	4.40	2.40
30	7.10	5.60	3.60
40	9.10	7.60	5.60
50	11.10	9.60	7.60
60	13.10	11.60	9.60
70	15.10	13.60	11.60

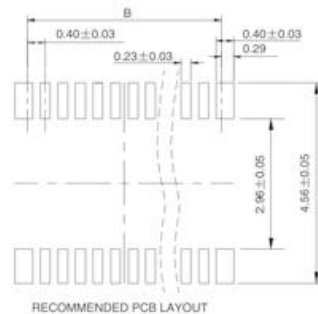

BTB 0.4MM XP FEMALE H=1.5MM

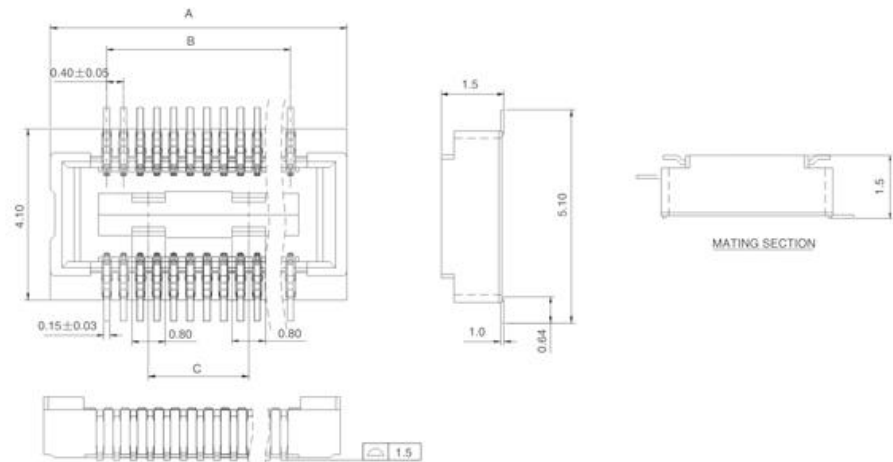

NOTE:

- 1.MATERIAL:
HOUSING:HIGHT-TEMP PLASTIC(WITHOUT HALOG)
UL 94V-0;
CONTACT:COPPER ALLOY;
- 2.PLATING:
CONTACT:GOLD OR TIN PLATED
ON N CKEL OVERALL.
- 3.RATING:
VOLTAGE RATING:100V AD/DC
TEMPERTURE RANGE:-25~+85D.

TABLE:

PIN NO.	A	B	C
24	7.10	4.40	2.40
30	8.30	5.60	3.60
40	10.30	7.60	5.60
50	12.30	9.60	7.60
60	14.30	11.60	9.60
70	16.30	13.60	11.60

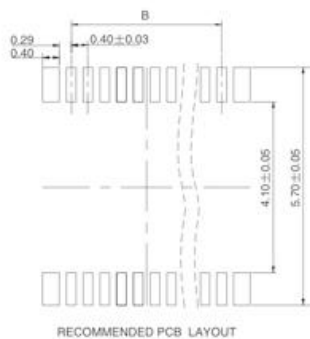

BTB 0.5MM XP MALE H=1.5~2.5MM

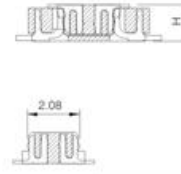
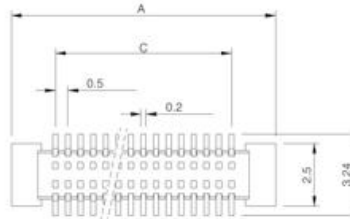

MATING HEIGHT(H)	FEMALE(H1)	MALE(H2)
1.5	1.32	0.5
2.0	1.82	0.5
2.5	2.32	0.5

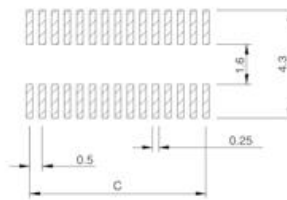
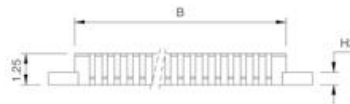

P.C.B LAYOUT

	A	B	C		A	B	C
8	5.00	3.00	1.50	56	17.00	15.00	13.50
10	5.50	3.50	2.00	58	17.50	15.50	14.00
12	6.00	4.00	2.50	60	18.00	16.00	14.50
14	6.50	4.50	3.00	62	18.50	16.50	15.00
16	7.00	5.00	3.50	64	19.00	17.00	15.50
18	7.50	5.50	4.00	66	19.50	17.50	16.00
20	8.00	6.00	4.50	68	20.00	18.00	16.50
22	8.50	6.50	5.00	70	20.50	18.50	17.00
24	9.00	7.00	5.50	72	21.00	19.00	17.50
26	9.50	7.50	6.00	74	21.50	19.50	18.00
28	10.00	8.00	6.50	76	22.00	20.00	18.50
30	10.50	8.50	7.00	78	22.50	20.50	19.00
32	11.00	9.00	7.50	80	23.00	21.00	19.50
34	11.50	9.50	8.00	82	23.50	21.50	20.00
36	12.00	10.00	8.50	84	24.00	22.00	20.50
38	12.50	10.50	9.00	86	24.50	22.50	21.00
40	13.00	11.00	9.50	88	25.00	23.00	21.50
42	13.50	11.50	10.00	90	25.50	23.50	22.00
44	14.00	12.00	10.50	92	26.00	24.00	22.50
46	14.50	12.50	11.00	94	26.50	24.50	23.00
48	15.00	13.00	11.50	96	27.00	25.00	23.50
50	15.50	13.50	12.00	98	27.50	25.50	24.00
52	16.00	14.00	12.50	100	28.00	26.00	24.50
54	16.50	14.50	13.00				

NOTES:

1. ALL DIMENSIONS ARE IN MILLIMETERS;
2. MATERIAL SEE TABLE;
3. ELECTRICAL PERFORMANCES:
 - 3-1 RATED VOLTAGE:60V AC/DC;
 - 3-2 RATED CURRENT:0.5A PER CONTACT MAX;
 - 3-3 DIELECTRICAL WITHSTANDING VOLTAGE:15
 - 3-4 INSULATION RESISTANCE: 1000 Mohms MIN
 - 3-5 CONTACT RESISTANCE:90 Mohms Max.
4. MECHANICAL PERFORMANCES:
 - 4-1 DURABILITY: 50 CYCLES;
 - 4-2 STORAGE TEMPERATURE:-25 ° TO+85 ° .
5. PART NO. DESCRIPTION:

CBT-0510XXM-XX
 MATING HEIGHT
 15=1.5MM MATING HEIGHT
 NUMBER OF POSITIONS

BTB 0.5MM XP FEMALE H=1.5~2.5MM

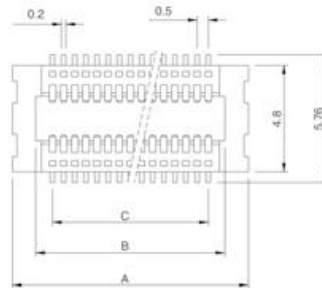

MATING HEIGHT(H)	FEMALE(H1)	MALE(H2)
1.5	1.32	0.5
2.0	1.82	0.5
2.5	2.32	0.5

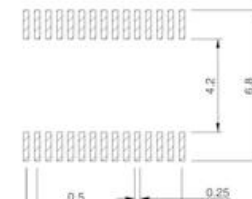

P.C.B LAYOUT

	A	B	C		A	B	C
8	5.00	3.00	1.50	56	17.00	15.00	13.50
10	5.50	3.50	2.00	58	17.50	15.50	14.00
12	6.00	4.00	2.50	60	18.00	16.00	14.50
14	6.50	4.50	3.00	62	18.50	16.50	15.00
16	7.00	5.00	3.50	64	19.00	17.00	15.50
18	7.50	5.50	4.00	66	19.50	17.50	16.00
20	8.00	6.00	4.50	68	20.00	18.00	16.50
22	8.50	6.50	5.00	70	20.50	18.50	17.00
24	9.00	7.00	5.50	72	21.00	19.00	17.50
26	9.50	7.50	6.00	74	21.50	19.50	18.00
28	10.00	8.00	6.50	76	22.00	20.00	18.50
30	10.50	8.50	7.00	78	22.50	20.50	19.00
32	11.00	9.00	7.50	80	23.00	21.00	19.50
34	11.50	9.50	8.00	82	23.50	21.50	20.00
36	12.00	10.00	8.50	84	24.00	22.00	20.50
38	12.50	10.50	9.00	86	24.50	22.50	21.00
40	13.00	11.00	9.50	88	25.00	23.00	21.50
42	13.50	11.50	10.00	90	25.50	23.50	22.00
44	14.00	12.00	10.50	92	26.00	24.00	22.50
46	14.50	12.50	11.00	94	26.50	24.50	23.00
48	15.00	13.00	11.50	96	27.00	25.00	23.50
50	15.50	13.50	12.00	98	27.50	25.50	24.00
52	16.00	14.00	12.50	100	28.00	26.00	24.50
54	16.50	14.50	13.00				

NOTES:

1. ALL DIMENSIONS ARE IN MILLIMETERS;
2. MATERIAL SEE TABLE;
3. ELECTRICAL PERFORMANCES:
 - 3-1 RATED VOLTAGE:60V AC/DC;
 - 3-2 RATED CURRENT:0.5A PER CONTACT MAX;
 - 3-3 DIELECTRICAL WITHSTANDING VOLTAGE:15
 - 3-4 INSULATION RESISTANCE: 1000 Mohms MIN
 - 3-5 CONTACT RESISTANCE:90 Mohms Max.
4. MECHANICAL PERFORMANCES:
 - 4-1 DURABILITY: 50 CYCLES;
 - 4-2 STORAGE TEMPERATURE:-25 ° TO+85 ° .
5. PART NO. DESCRIPTION:

CBT-0510XXF-XX
 MATING HEIGHT
 15=1.5MM MATING HEIGHT
 NUMBER OF POSITIONS

BTB 0.5MM XP MALE H=3.0~8.5MM

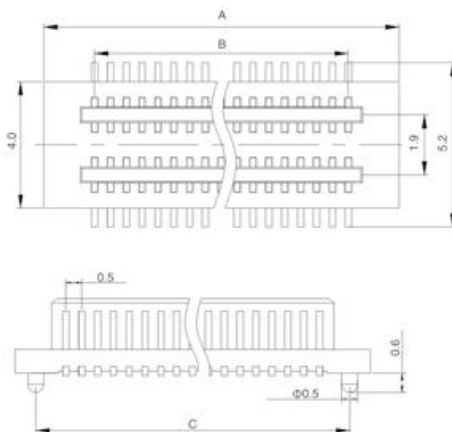

MATING HEIGHT	FEMALE(H1)	MALE(H2)
3.0	2.2	0.8
3.5	2.2	1.3
4.0	3.0	1.0
4.5	3.5	1.0
5.0	4.0	1.0
5.5	4.5	1.0
6.0	4.0	2.0
6.5	4.5	2.0
7.0	3.0	4.0
7.5	3.5	4.0
8.0	4.0	4.0
8.5	4.5	4.0

NOTES:

- ALL DIMENSIONS ARE IN MILLIMETERS;
- MATERIAL SEE TABLE;
- ELECTRICAL PERFORMANCES:
 - 3-1 RATED VOLTAGE:60V AC/DC;
 - 3-2 RATED CURRENT:0.5A PER CONTACT MAX;
 - 3-3 DIELETRICAL WITHSTANGDING VOLTAGE:150V;
 - 3-4 INSULATION RESISTANCE: 1000 Mohms MIN;
 - 3-5 CONTACT RESISTANCE:90 Mohms Max.
- MECHANICAL PERFORMANCES:
 - 4-1 DURABILITY: 50 CYCLES;
 - 4-2 STORAGE TEMPERATURE:-25 ° TO+85 ° .
- PART NO. DESCRIPTION:
 - CBT-0520XXM-XX

_____ MATING HEIGHT
 30=3.0MM MATING HEIGHT
 _____ NUMBER OF POSITIONS

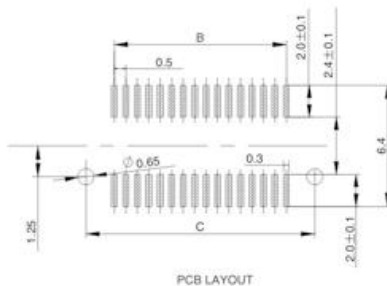

	A	B	C		A	B	C
8P	4.70	1.50	3.40	36P	11.70	8.50	10.40
10P	5.20	2.00	3.90	38P	12.20	9.00	10.90
12P	5.70	2.50	4.40	40P	12.70	9.50	11.40
14P	6.20	3.00	4.90	42P	13.20	10.00	11.90
16P	6.70	3.50	5.40	44P	13.70	10.50	12.40
18P	7.20	4.00	5.90	46P	14.20	11.00	12.90
20P	7.70	4.50	6.40	48P	14.70	11.50	13.40
22P	8.20	5.00	6.90	50P	15.20	12.00	13.90
24P	8.70	5.50	7.40	60P	17.70	14.50	16.40
26P	9.20	6.00	7.90	70P	20.20	17.00	18.90
28P	9.70	6.50	8.40	80P	22.70	19.50	21.40
30P	10.20	7.00	8.90	90P	25.20	22.00	23.90
32P	10.70	7.50	9.40	100P	27.70	24.50	26.40
34P	11.20	8.00	9.90				

BTB 0.5MM XP FEMALE H=3.0~8.5MM

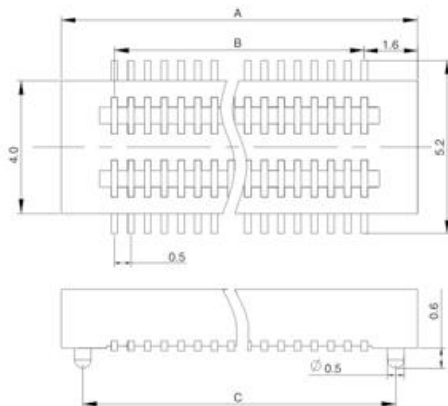

MATING HEIGHT	FEMALE(H1)	MALE(H2)
3.0	2.2	0.8
3.5	2.2	1.3
4.0	3.0	1.0
4.5	3.5	1.0
5.0	4.0	1.0
5.5	4.5	1.0
6.0	4.0	2.0
6.5	4.5	2.0
7.0	3.0	4.0
7.5	3.5	4.0
8.0	4.0	4.0
8.5	4.5	4.0

NOTES:

- ALL DIMENSIONS ARE IN MILLIMETERS;
- MATERIAL SEE TABLE;
- ELECTRICAL PERFORMANCES:
 - 3-1 RATED VOLTAGE:60V AC/DC;
 - 3-2 RATED CURRENT:0.5A PER CONTACT MAX;
 - 3-3 DIELETRICAL WITHSTANGDING VOLTAGE:150V;
 - 3-4 INSULATION RESISTANCE: 1000 Mohms MIN;
 - 3-5 CONTACT RESISTANCE:90 Mohms Max.
- MECHANICAL PERFORMANCES:
 - 4-1 DURABILITY: 50 CYCLES;
 - 4-2 STORAGE TEMPERATURE:-25 ° TO+85 ° .
- PART NO. DESCRIPTION:
 - CBT-0520XXM-XX

_____ MATING HEIGHT
 30=3.0MM MATING HEIGHT
 _____ NUMBER OF POSITIONS

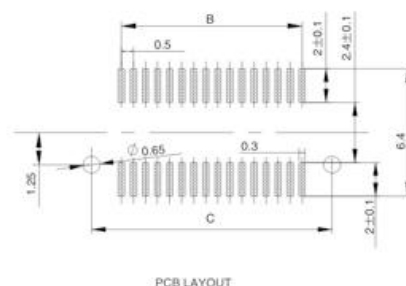

	A	B	C		A	B	C
8P	4.70	1.50	3.40	36P	11.70	8.50	10.40
10P	5.20	2.00	3.90	38P	12.20	9.00	10.90
12P	5.70	2.50	4.40	40P	12.70	9.50	11.40
14P	6.20	3.00	4.90	42P	13.20	10.00	11.90
16P	6.70	3.50	5.40	44P	13.70	10.50	12.40
18P	7.20	4.00	5.90	46P	14.20	11.00	12.90
20P	7.70	4.50	6.40	48P	14.70	11.50	13.40
22P	8.20	5.00	6.90	50P	15.20	12.00	13.90
24P	8.70	5.50	7.40	60P	17.70	14.50	16.40
26P	9.20	6.00	7.90	70P	20.20	17.00	18.90
28P	9.70	6.50	8.40	80P	22.70	19.50	21.40
30P	10.20	7.00	8.90	90P	25.20	22.00	23.90
32P	10.70	7.50	9.40	100P	27.70	24.50	26.40
34P	11.20	8.00	9.90				

BTB 0.8MM XP MALE H=4.0~8.5MM

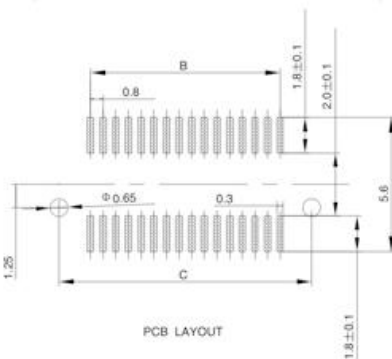
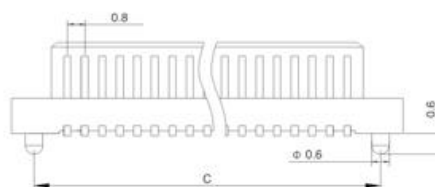
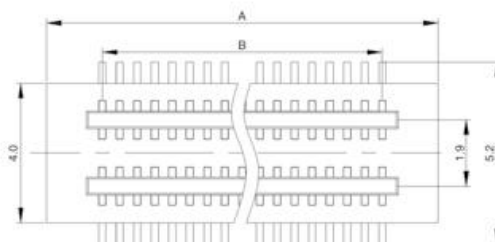
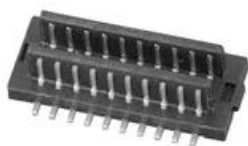

MATING HEIGHT	FEMALE(H1)	MALE(H2)
4.0	3.0	1.0
4.5	3.5	1.0
5.0	4.0	1.0
5.5	4.5	1.0
6.0	4.0	2.0
6.5	4.5	2.0
7.0	3.0	4.0
7.5	3.5	4.0
8.0	4.0	4.0
8.5	4.5	4.0

NOTES:

- ALL DIMENSIONS ARE IN MILLIMETERS;
- MATERIAL SEE TABLE;
- ELECTRICAL PERFORMANCES:
 - 3-1 RATED VOLTAGE:60V AC/DC;
 - 3-2 RATED CURRENT:0.5A PER CONTACT MAX;
 - 3-3 DIELECTRICAL WITHSTANGDING VOLTAGE:15
 - 3-4 INSULATION RESISTANCE: 1000 Mohms MIN
 - 3-5 CONTACT RESISTANCE:90 Mohms Max.
- MECHANICAL PERFORMANCES:
 - 4-1 DURABILITY: 50 CYCLES;
 - 4-2 STORAGE TEMPERATURE:-25 ° TO+85 ° .
- PART NO. DESCRIPTION:

CBT-0820XXM-XX
 MATING HEIGHT
 40=4.0MM MATING HEIGHT
 NUMBER OF POSITIONS

	A	B	C		A	B	C
8P	5.10	2.40	4.20	34P	15.50	12.80	14.60
10P	5.90	3.20	5.00	36P	16.30	13.60	15.40
12P	6.70	4.00	5.80	38P	17.10	14.40	16.20
14P	7.50	4.80	6.60	40P	17.90	15.20	17.00
16P	8.30	5.60	7.40	42P	18.70	16.00	17.80
18P	9.10	6.40	8.20	44P	19.50	16.80	18.60
20P	9.90	7.20	9.00	46P	20.30	17.60	19.40
22P	10.70	8.00	9.80	48P	21.10	18.40	20.20
24P	11.50	8.80	10.60	50P	21.90	19.20	21.00
26P	12.30	9.60	11.40	60P	25.90	23.20	25.00
28P	13.10	10.40	12.20	70P	29.90	27.20	29.00
30P	13.90	11.20	13.00	80P	33.90	31.20	33.00
32P	14.70	12.00	13.80				

BTB 0.8MM XP FEMALE H=4.0~8.5MM

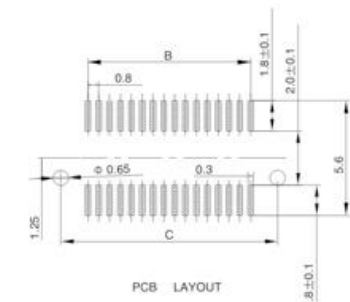
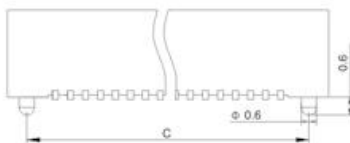
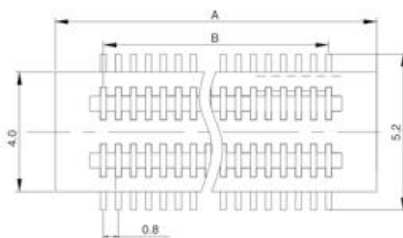
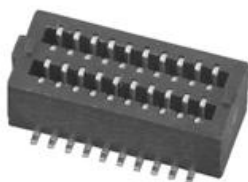

MATING HEIGHT	FEMALE(H1)	MALE(H2)
4.0	3.0	1.0
4.5	3.5	1.0
5.0	4.0	1.0
5.5	4.5	1.0
6.0	4.0	2.0
6.5	4.5	2.0
7.0	3.0	4.0
7.5	3.5	4.0
8.0	4.0	4.0
8.5	4.5	4.0

NOTES:

- ALL DIMENSIONS ARE IN MILLIMETERS;
- MATERIAL SEE TABLE;
- ELECTRICAL PERFORMANCES:
 - 3-1 RATED VOLTAGE:60V AC/DC;
 - 3-2 RATED CURRENT:0.5A PER CONTACT MAX;
 - 3-3 DIELECTRICAL WITHSTANGDING VOLTAGE:150V;
 - 3-4 INSULATION RESISTANCE: 1000 Mohms MIN;
 - 3-5 CONTACT RESISTANCE:90 Mohms Max.
- MECHANICAL PERFORMANCES:
 - 4-1 DURABILITY: 50 CYCLES;
 - 4-2 STORAGE TEMPERATURE:-25 ° TO+85 ° .
- PART NO. DESCRIPTION:

CBT-0820XXM-XX
 MATING HEIGHT
 40=4.0MM MATING HEIGHT
 NUMBER OF POSITIONS

	A	B	C		A	B	C
8P	5.10	2.40	4.20	34P	15.50	12.80	14.60
10P	5.90	3.20	5.00	36P	16.30	13.60	15.40
12P	6.70	4.00	5.80	38P	17.10	14.40	16.20
14P	7.50	4.80	6.60	40P	17.90	15.20	17.00
16P	8.30	5.60	7.40	42P	18.70	16.00	17.80
18P	9.10	6.40	8.20	44P	19.50	16.80	18.60
20P	9.90	7.20	9.00	46P	20.30	17.60	19.40
22P	10.70	8.00	9.80	48P	21.10	18.40	20.20
24P	11.50	8.80	10.60	50P	21.90	19.20	21.00
26P	12.30	9.60	11.40	60P	25.90	23.20	25.00
28P	13.10	10.40	12.20	70P	29.90	27.20	29.00
30P	13.90	11.20	13.00	80P	33.90	31.20	33.00
32P	14.70	12.00	13.80				

BTB 0.8MM XP MALE H=5.2MM

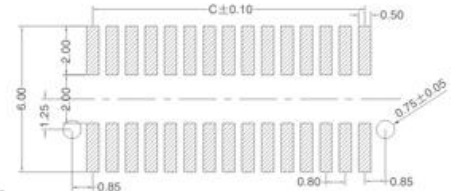
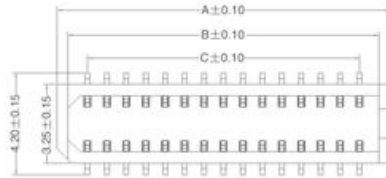
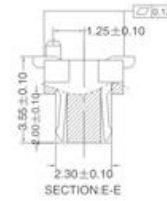
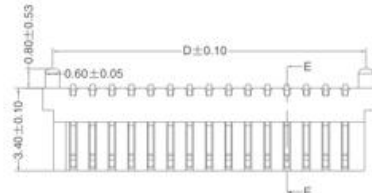
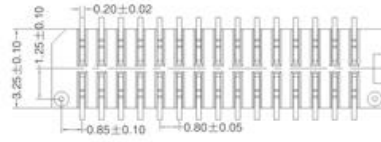

RECOMMENDED PCB LAYOUT

PIN.NO	A	B	C	D
10	5.7	4.8	3.2	4.9
12	6.5	5.6	4.0	5.7
14	7.3	6.4	4.8	6.5
16	8.1	7.2	5.6	7.3
18	8.9	8.0	6.4	8.1
20	9.7	8.8	7.2	8.9
22	10.5	9.6	8.0	9.7
24	11.3	10.4	8.8	10.5
26	12.1	11.2	9.6	11.3
28	12.9	12.0	10.4	12.1
30	13.7	12.8	11.2	12.9
32	14.5	13.6	12.0	13.7
40	17.7	16.8	15.2	16.9
50	21.7	20.8	19.2	20.9

Electrical:

1. Voltage: 50V AC(RMS)/DC
2. Current: 0.5A AC(RMS)/DC
3. Contact Resistance: 90 mΩ max
4. Withstanding Voltage: 150V AC/RMS
5. Insulation Resistance: 500 mΩ min.
6. Operating Temperature: -20°C~+85°C

Material:

Housing: High temperature Plastic(UL94V-0)
Terminal: Copper Alloy

BTB 0.8MM XP FEMALE H=5.2MM

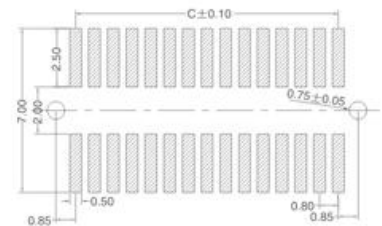
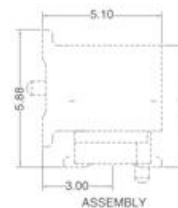
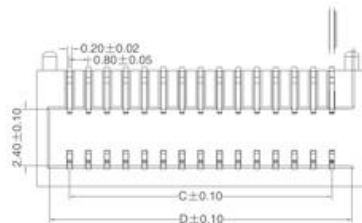
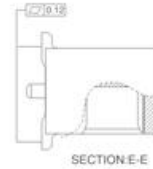
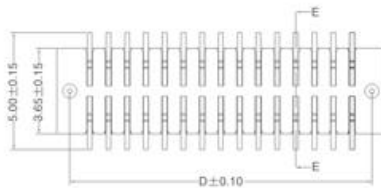
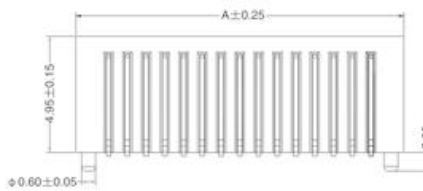

RECOMMENDED PCB LAYOUT

PIN.NO	A	B	C	D
10	5.7	4.8	3.2	4.9
12	6.5	5.6	4.0	5.7
14	7.3	6.4	4.8	6.5
16	8.1	7.2	5.6	7.3
18	8.9	8.0	6.4	8.1
20	9.7	8.8	7.2	8.9
22	10.5	9.6	8.0	9.7
24	11.3	10.4	8.8	10.5
26	12.1	11.2	9.6	11.3
28	12.9	12.0	10.4	12.1
30	13.7	12.8	11.2	12.9
32	14.5	13.6	12.0	13.7
40	17.7	16.8	15.2	16.9
50	21.7	20.8	19.2	20.9

Electrical:

1. Voltage: 50V AC(RMS)/DC
2. Current: 0.5A AC(RMS)/DC
3. Contact Resistance: 90 mΩ max
4. Withstanding Voltage: 150V AC/RMS
5. Insulation Resistance: 500 mΩ min.
6. Operating Temperature: -20°C~+85°C

Material:

Housing: High temperature Plastic(UL94V-0)
Terminal: Copper Alloy

PH 1.27MM XP SMT H=5.3MM

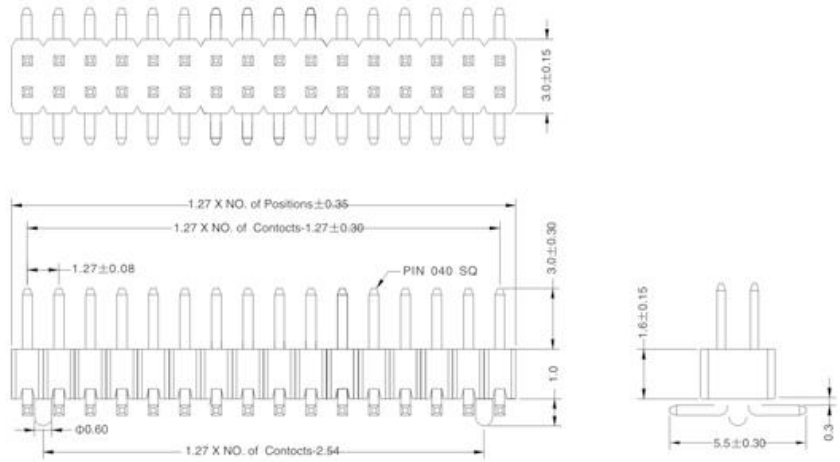
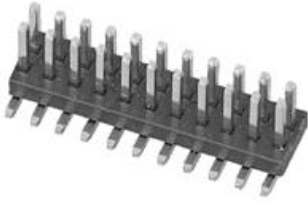

SPECIFICATIONS

Current Rating : 1AMP
 Operation Temperature: -40°C to +105°C
 Contact Resistance: 20mΩ Max.
 Insulation Resistance: 1000 MΩ Min.
 Withstanding Voltage : AC 500V
 Insulator Material: Polyester(UL94V-0)
 Standard: Nylon-6T
 Contact Material : Brass
 Contact plating : Au or Sn Over 50u"Ni

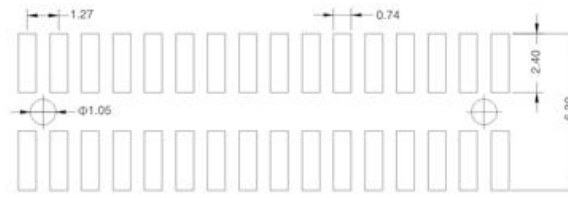

PCB LAYOUT

FH 1.27MM XP SMT H=3.4MM

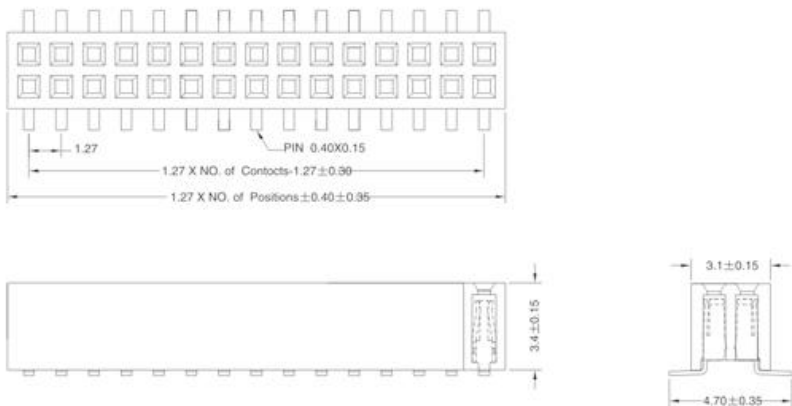
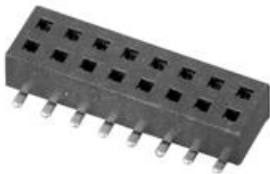

SPECIFICATIONS

Current Rating : 1AMP
 Operation Temperature: -40°C to +105°C
 Contact Resistance: 20mΩ Max.
 Insulation Resistance: 1000 MΩ Min.
 Withstanding Voltage : AC 500V
 Insulator Material: Polyester(UL94V-0)
 Standard: Nylon-6T
 Contact Material : Phospor Bronze
 Contact plating : Au or Sn Over 50u"Ni



PCB LAYOUT

PH 2.0MM XP DIP180 H=8.7MM

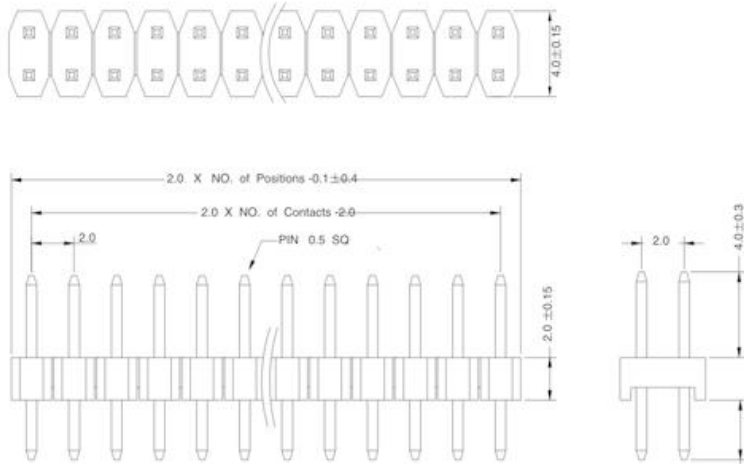

SPECIFICATIONS

Current Rating : 1.5AMP
 Operation Temperature: -40°C to +105°C
 Contact Resistance: 20mΩ Max.
 Insulation Resistance: 1000 MΩ Min.
 Withstanding Voltage : AC 500V
 Insulator Material: Polyester(UL94V-0)
 Standard: PBT or PA6T
 Contact Material : Brass
 Contact plating : Au or Sn Over 50u"Ni

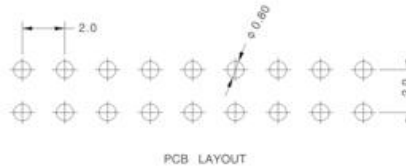

FH 2.0MM XP DIP180 H=4.3MM

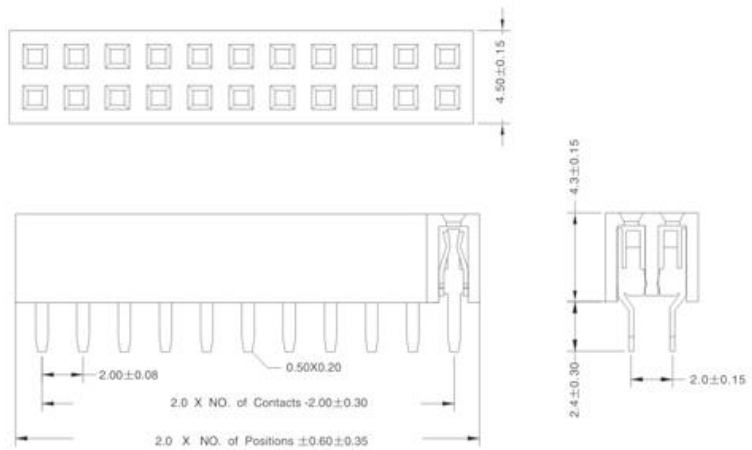

SPECIFICATIONS

Current Rating : 1.5AMP
 Operation Temperature: -40°C to +105°C
 Contact Resistance: 20mΩ Max.
 Insulation Resistance: 1000 MΩ Min.
 Withstanding Voltage : AC 500V
 Insulator Material: Polyester(UL94V-0)
 Standard: Nylon-6T
 Contact Material : Phosphor Bronze
 Contact plating : Au Over 50u"Ni

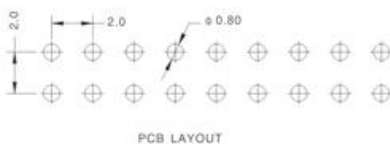

PH 2.54MM XP DIP90 L=12.9MM

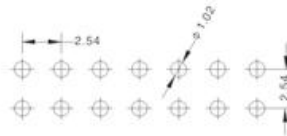
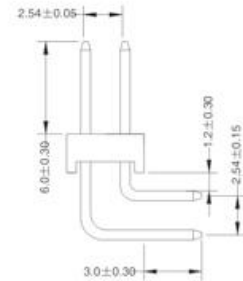
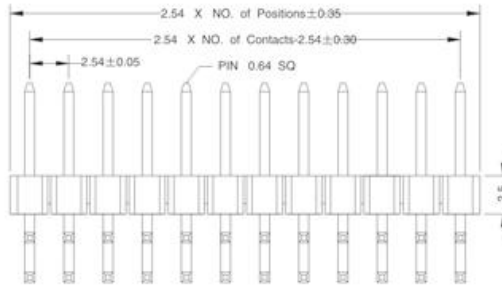

PCB LAYOUT

SPECIFICATIONS

- Current Rating : 3AMP
- Operation Temperature: -40°C to +105°C
- Contact Resistance: 20m Ω Max.
- Insulation Resistance: 1000 M Ω Min.
- Withstanding Voltage : AC 1000V
- Insulator Material: Polyester(UL94V-0)
- Standard: PBT
- Contact Material : Brass
- Contact plating : Au or Sn Over 50u"Ni

FH 2.54MM XP DIP90 H=8.5MM

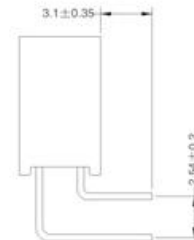
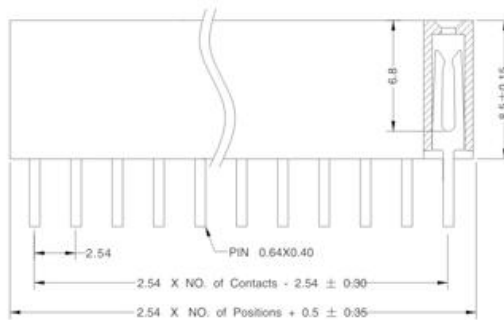
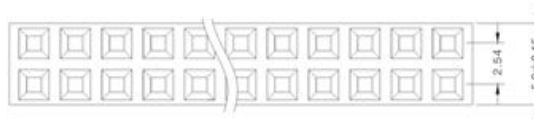

PCB LAYOUT

SPECIFICATIONS

- Current Rating : 3AMP
- Operation Temperature: -40°C to +105°C
- Contact Resistance: 20m Ω Max.
- Insulation Resistance: 1000 M Ω Min.
- Withstanding Voltage : AC 1000V
- Insulator Material: Polyester(UL94V-0)
- Standard: PBT
- Contact Material : Phosphor bronze
- Contact plating : Au or Sn Over 50u"Ni

USB TYPE C FEMALE DIP L=10.85MM

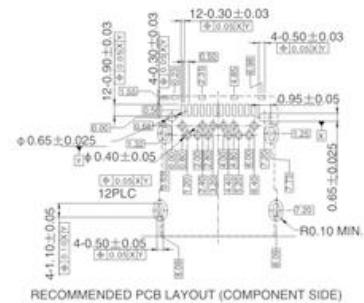
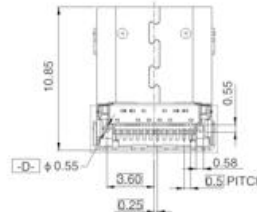
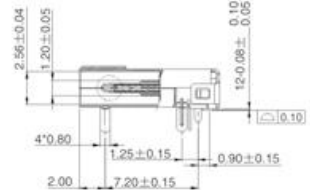
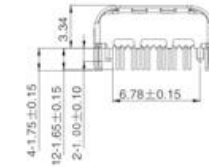
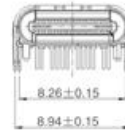
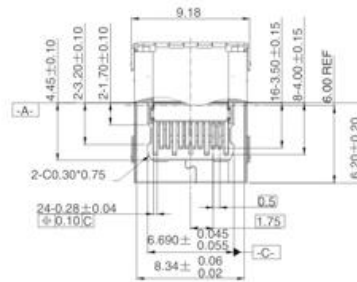

NOTE:

1.MATERIAL:

- 1.1 INSULATOR: HIGH TEMPERATURE PLASTIC UL 94 V-0;
- 1.2 CONTACT: COPPER ALLOY(T=0.15mm)
- 1.3 SHELL:STAINLESS STEEL(T=0.20mm)

2.ELECTRICAL CHARACTERISTICS:

- 2.1 CONTACT RESISTANCE: 40mΩ Max FOR INITIAL, 10mΩ CHANGE AFTER TEST.MEASURE AT 20mV, 100mA.
- 2.2 CONTACT CURRENT RATING:5A FOR VBUS PIN; 1.25A FOR VCONN PIN.
- 2.3 DIELECTRIC WITHSTANDING VOLTAGE: 100V AC R.M.S.
- 2.4 INSULATION RESISTANCE 100MΩ Min
- 2.5 OPERATING TEMPERATURE: -40℃~85℃

3.MECHANICAL CHARACTERISTICS:

- 3.1 MATING FORCE: 5~20N.
- 3.2 UNMATED FORCE : 8~20N AFTER TEST
- 3.3 DURABILITY: 10,000 CYCLES

4.PLATING

- 4.1 TERMINAL CONTACT:(SEE TAB) GOLD PLATING ALL OVER 50u" Min NICKEL AND 80u"Min ALL OVER 50u" Min NICKEL ON SOLDER AREA
- 4.2 SHELL: 50u" Min. NICKEL ALL OVER.

USB TYPE C FEMALE DIP L=10MM

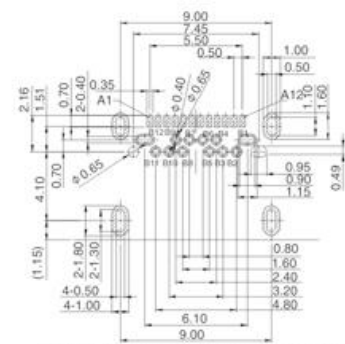
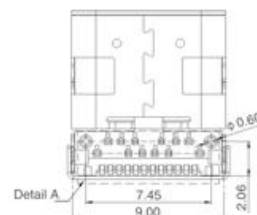
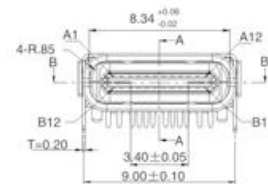
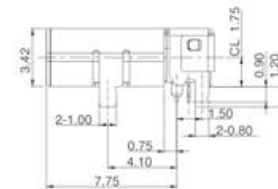
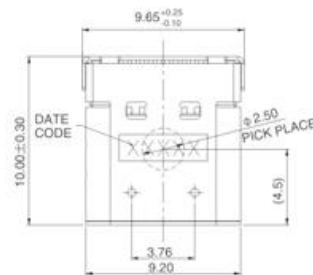

Note:

1.material:

- 1.1 Insulator: High Temperature Plastic UI 94 V-0;
- 1.2 Contact: Copper Alloy(t=0.15mm)
- 1.3 Shell:stainless Steel(t=0.20mm)

2.electrical Characteristics:

- 2.1 Contact Resistance: 40mΩ Max For Initial, 10mΩ Change After Test.measure At 20mv, 100ma.
- 2.2 Contact Current Rating:5a For Vbus Pin; 1.25a For Vconn Pin.
- 2.3 Dielectric Withstanding Voltage: 100v Ac R.m.s.
- 2.4 Insulation Resistance 100mΩ Min
- 2.5 Operating Temperature: -40℃~85℃

3.Mechanical Characteristics:

- 3.1 Mating Force: 5~20n.
- 3.2 Unmated Force :8~20n After Test
- 3.3 Durability: 10,000 Cycles

4.Plating

- 4.1 Terminal Contact:(see Tab) Gold Plating All Over 50u" Min Nickel And 80u"min All Over 50u" Min Nickel On Solder Area
- 4.2 Shell: 50u" Min. Nickel All Over.

RECOMMEND P.C.B LAYOUT (COMPONENT SIDE)
TOLERANCE FOR PCB LAYOUT IS ± 0.05
KEEP OUT AREA

USB TYPE C FEMALE DIP L=8.65MM

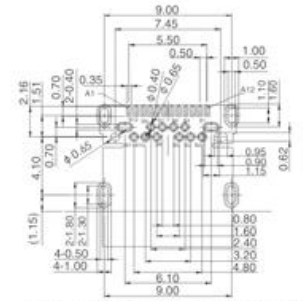
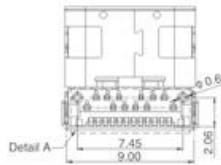
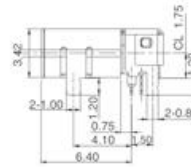
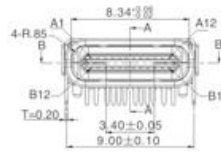
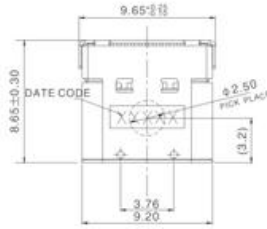

RECOMMEND P.C.B LAYOUT (COMPONENT SIDE)
TOLERANCE FOR PCB LAYOUT IS ± 0.05
KEEP OUT AREA

NOTE:

1.MATERIAL:

- 1.1 INSULATOR: HIGH TEMPERATURE PLASTIC UL 94 V-0;
- 1.2 CONTACT: COPPER ALLOY(T=0.15mm)
- 1.3 SHELL: STAINLESS STEEL(T=0.20mm)

2.ELECTRICAL CHARACTERISTICS:

- 2.1 CONTACT RESISTANCE: 40mΩ Max FOR INITIAL. 10mΩ CHANGE AFTER TEST.MEASURE AT 20mV, 100mA.
- 2.2 CONTACT CURRENT RATING:5A FOR VBUS PIN; 1.25A FOR VCONN PIN.
- 2.3 DIELECTRIC WITHSTANDING VOLTAGE: 100V AC R.M.S.
- 2.4 INSULATION RESISTANCE 100MΩ Min
- 2.5 OPERATING TEMPERATURE: -40℃~85℃

3.MECHANICAL CHARACTERISTICS:

- 3.1 MATING FORCE : 5~20N.
- 3.2 UNMATED FORCE :8~20N AFTER TEST
- 3.3 DURABILITY: 10,000 CYCLES

4.PLATING

- 4.1 TERMINAL CONTACT;(SEE TAB) GOLD PLATING ALL OVER 50u" Min NICKEL AND 80u"Min ALL OVER 50u" Min NICKEL ON SOLDER AREA
- 4.2 SHELL: 50u" Min. NICKEL ALL OVER.

USB TYPE C FEMALE SINKING-BOARD TYPE 0.8SMT

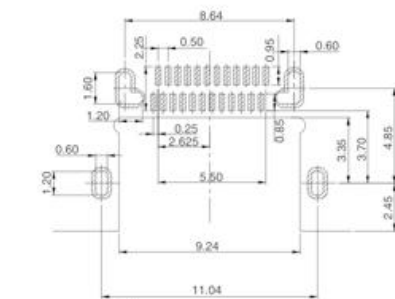
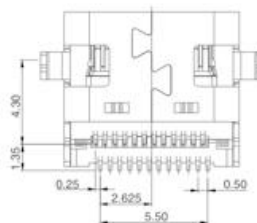
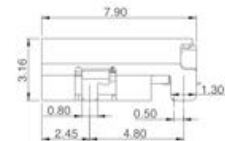
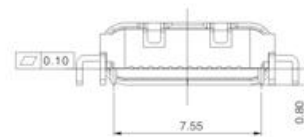
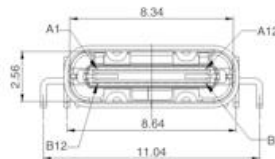
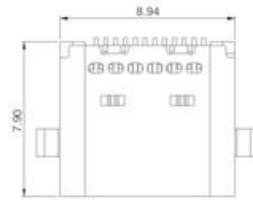

CONNECTOR FRONT EDGE
RECOMMENDED P.C.B. LAYOUT
TOLERANCE UNSPECIFIED ±0.05mm

NOTES:

SPECIFICATION:

- 1. CURRENT RATING: 1.5A MAX
- 2. VOLTAGE: 100VAC
- 3. TEMPERATURE RANGE: -30℃ ~85℃
- 4. CONTACT RESISTANCE: 40 MILLIONHM MAX
- 5. INSULATION RESISTANCE: 100 MEGOHMS MIN.
- 6. LNSERTION FORCE : 5N~20N
- 7. UNMATING FORCE: 8N~20N
- 8. DURABILITY: 10,000CYCLES

USB TYPE C FEMALE L=9.95MM SINKING-BOARD TYPE

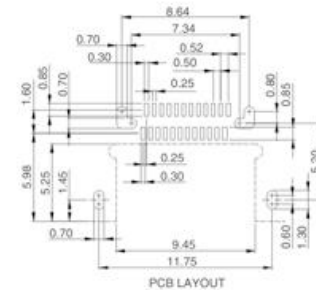
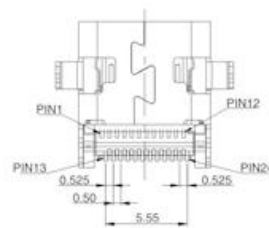
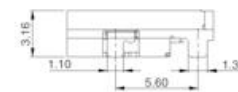
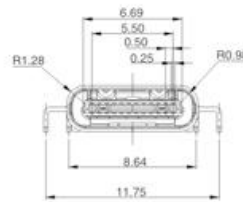
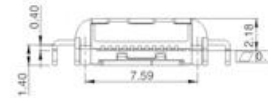
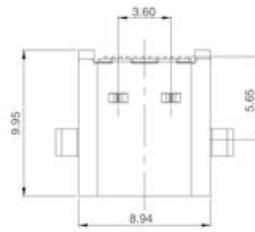

NOTES:

1.MECHANICAL:

INSERTION: 5~20N.

EXTRACTION: 8~20N.

DURABILITY: 10000 CYCLES

2.ELECTRICAL:

CURRENT: 5A MIN FOR VBUS;
0.25A MIN FOR OTHER.

VOLTAGE: 5V AC

WITHSTANDING VOLTAGE:100V AC.

CONTACT RESISTANCE:40mΩ MAX.

INSULATION RESISTANCE 100mΩ MIN .

3.ENVIRONMENTAL

TEMPERATURE RANGE -55°C~+85°C

USB TYPE C FEMALE L=8.7MM SINKING-BOARD TYPE

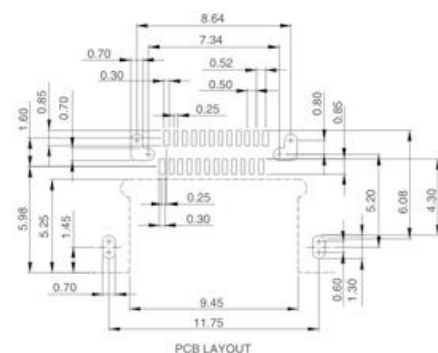
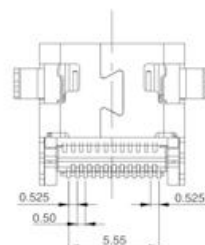
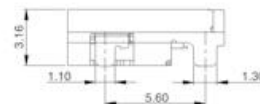
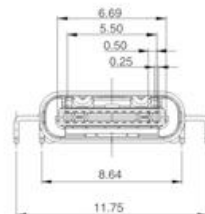
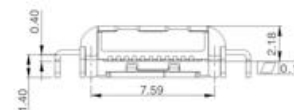
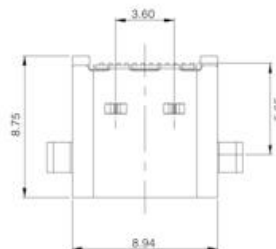

NOTES:

1.MECHANICAL:

INSERTION: 5~20N.

EXTRACTION: 8~20N.

DURABILITY: 10000 CYCLES

2.ELECTRICAL:

CURRENT: 5A MIN FOR VBUS;
0.25A MIN FOR OTHER.

VOLTAGE: 5V AC

WITHSTANDING VOLTAGE:100V AC.

CONTACT RESISTANCE:40mΩ MAX.

INSULATION RESISTANCE 100mΩ MIN .

3.ENVIRONMENTAL

TEMPERATURE RANGE -55°C~+85°C

USB TYPE C FEMALE L=10.3MM SINKING-BOARD TYPE

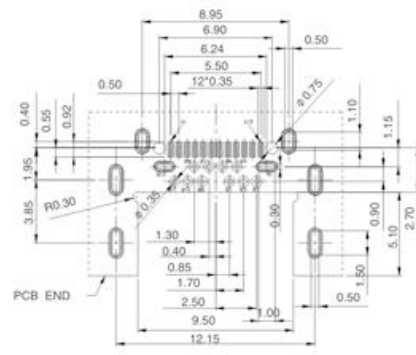
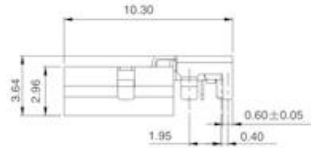
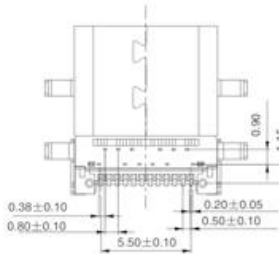
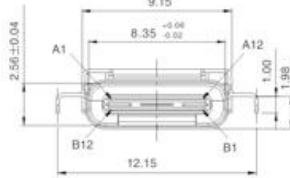
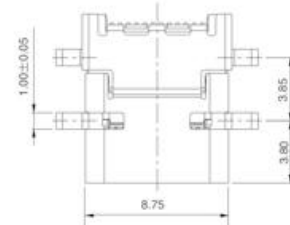

PCB LAYOUT (RECOMMENDED)
(Tol:±0.05)

SPECIFICATION

MATERIAL

See drawing

STANDARD DATA

Rating current: 1.5A

ELECTRICAL

Insulator resistance: 100M ohms Min

Withstanding voltage: 100VAC/minute

Contact resistance: 40m ohms Max

MECHANICAL

Mating force:5~20N.

Unmating force: 8~20N.

Durability: 10000 cycles Min.

USB TYPE C FEMALE VERTICAL ENTRY TYPE

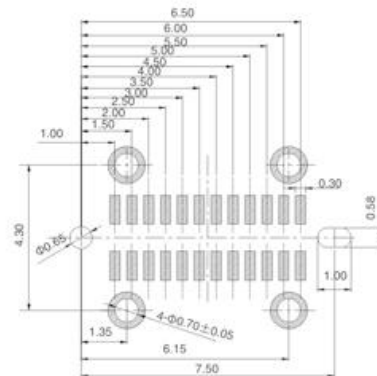
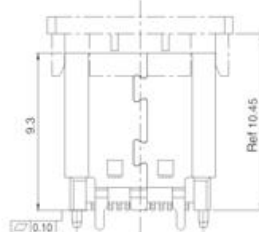
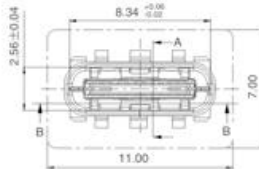
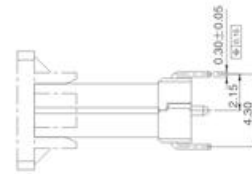
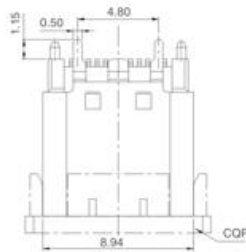

RECOMMENDED P.C.B. LAYOUT(T:1.00mm)
TOLERANCE UNSPECIFIED±0.05mm

NOTES:

SPECIFICATION:

1. CURRENT RATING: 3.0A MAX
2. VOLTAGE: 100VAC
3. TEMPERATURE RANGE: -30°C~85°C
4. CONTACT RESISTANCE: 40 MILLIONHM MAX
5. INSULATION RESISTANCE: 100MEGOHMS MIN.
6. INSERTION FORCE: 5N~20N
7. UNMATING FORCE: 8N~20N
8. DURABILITY: 10, 000 CYCLES

USB TYPE C MALE SMT SINKING-BOARD TYPE

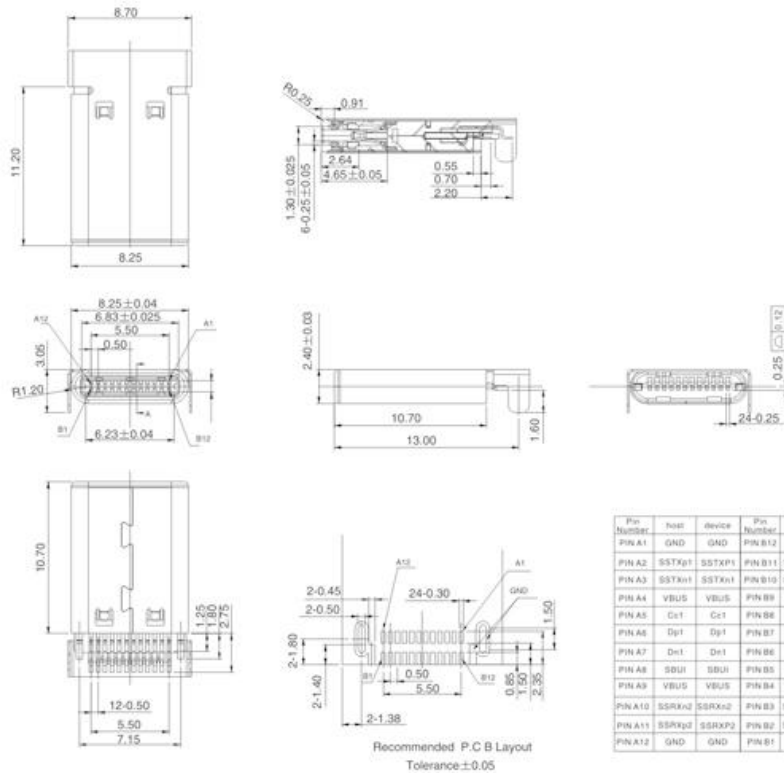

NOTES:

1. MATERIAL:

HOUSING: LCP+ 30% G.F, UL94V-0 COLOR: BLACK
 CONTACT: C5210-RH, 0.15mm.
 SHELL: SUS301,0.20mm
 EMI: SUS304, 0.10mm
 SHIELD CONTACT: SUS301,0.10mm

2. FINISH

Contacts: [G/F]Au PLATED /80u"Sn/50u" Ni Plated
 Shell: 30u" Nickel Plated
 SHIELD CONTACT: 30u" NICKEL Plated

Pin Number	host	device	Pin Number	host	device
PIN A1	GND	GND	PIN B12	GND	GND
PIN A2	SSTXp1	SSTXp1	PIN B11	SSTXp1	SSTXp1
PIN A3	SSTXn1	SSTXn1	PIN B10	SSTXn1	SSTXn1
PIN A4	VBUS	VBUS	PIN B9	VBUS	VBUS
PIN A5	Cx1	Cx1	PIN B8	SBU2	SBU2
PIN A6	Dp1	Dp1	PIN B7	Dx2	Dx2
PIN A7	Dn1	Dn1	PIN B6	Dp2	Dp2
PIN A8	SBU1	SBU1	PIN B5	Cx2	Cx2
PIN A9	VBUS	VBUS	PIN B4	VBUS	VBUS
PIN A10	SSRXn2	SSRXn2	PIN B3	SSTXn2	SSTXn2
PIN A11	SSRXp2	SSRXp2	PIN B2	SSTXp2	SSTXp2
PIN A12	GND	GND	PIN B1	GND	GND

USB TYPE C MALE

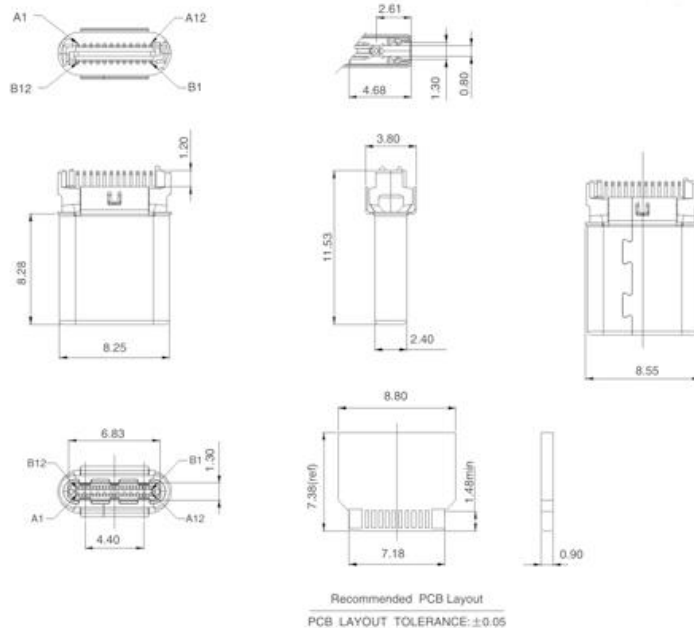

NOTES:

1. ELECTRICAL CHARACTERISTICS:

- 1-1. Contact current rating:
5.0A for Vbus pin and is corresponding GND pin.
0.25A min for all other contact.
- 1-2. Contact resistance:
30 Milliohms Max for Vbus and GND contact.
50 Milliohms Max for all other contact.
- 1-3. Dielectric withstanding voltage: 100V AC Min.
- 1-4. Insulation resistance: 100Megohms Min.

2. MECHANICAL CHARACTERISTICS:

- 2-1. Connector insertion force: 5~20N.
At a maximum rate of 12.5mm per second.
- 2-2. Connector extraction force: 8~20N.
At a maximum rate of 12.5mm per second.
- 2-3. Durability: 10000cycles.
- 2-4. Operating temperature: -55°C~+85°C.

3. DIMENSIONS ARE IN MILLIMETERS, BRACKETED DIMENSIONS ARE INCHES EQUIVALENTS.

4. THE CONNECTOR IS ROHS COMPLIANT AND HALOGEN FREE COMPLIANT.

Recommended PCB Layout
 PCB LAYOUT TOLERANCE: ±0.05

A12	A11	A10	A9	A8	A7	A6	A5	A4	A3	A2	A1
GND	Rx2+	Rx2-		SBU1	D-	D+	CC	SBU2	TX1-	TX1+	GND
GND	Tx2+	Tx2-	VBUS	VCOON			SBU2	VBUS	Rx1-	Rx1+	GND
B1	B2	B3	B4	B5	B6	B7	B8	B9	B10	B11	B12

USB 3.0 AF 9P DIP90

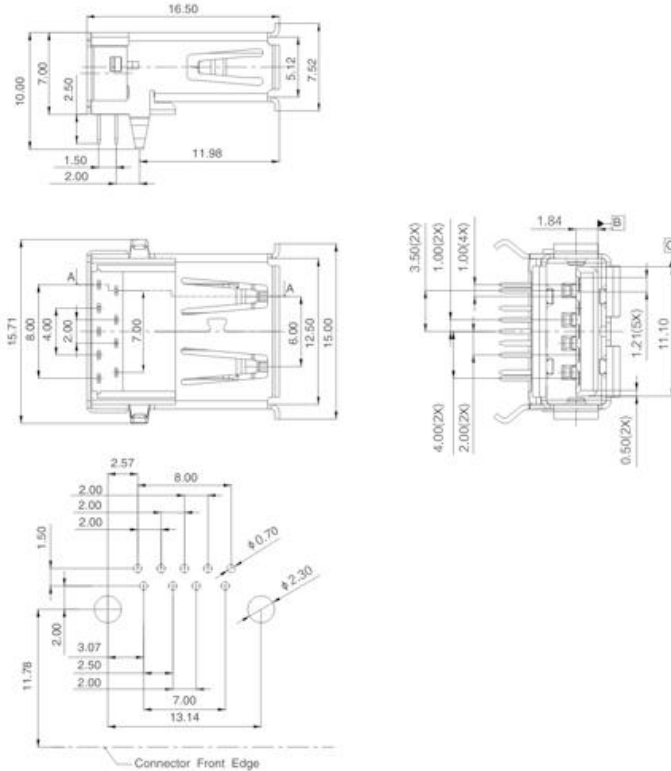

ELECTRICAL CHARAC TERISTICS:
 30V DC/AC 1A MAX.
 CONTACT RESISTANCE: 30m Ω MAX
 INSULATION RESISTANCE: 100m Ω MIN, AT 500V DC.
 30V DC/AC 1A MAX.
 DIELECTRIC STRENGTH: 750V AC/1 MINUTE.
 INSERTION FORCE: 3.6Kgf MAX
 WITHDRAWAL: 1.0Kgf MIN

REFERENCE PCB LAYOUT

USB 3.0 AF SINKING-BOARD TYPE 3.5DIP

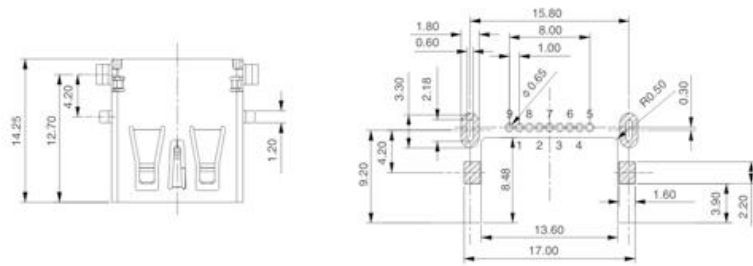

REFERENCE PCB LAYOUT (1.0-1.60±0.05)

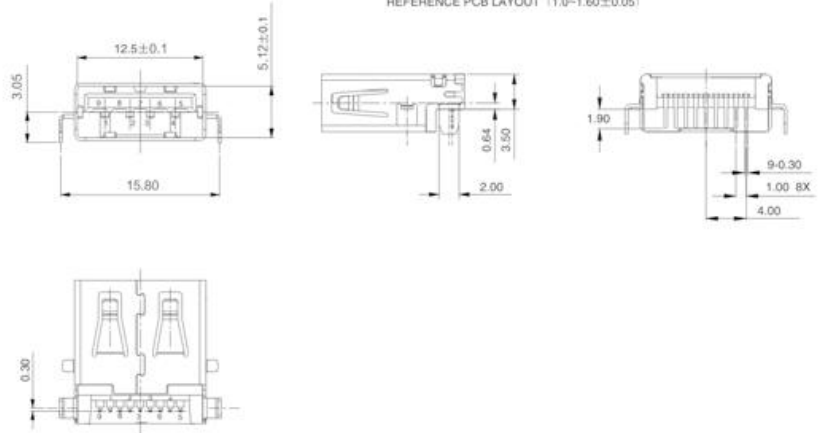

NOTES:
 1.ELECTRONIC:
 CONTACT RESISTANCE: 30mohm MAX
 INSULATION RESISTANCE: 100 mohm MIN
 WITHSTAND VOLTAGE:AC 100V,1min.
 2.MECHANICAL:
 DURABILITY: 1500 CYCLE.
 3.ENVIRONMENT CHARACTERISTICS:
 OPERTING TEMPERATURE:-25°C TO +85°C

USB 3.0 MALE SMT SINKING-BOARD TYPE

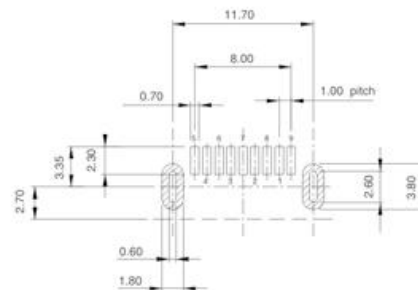
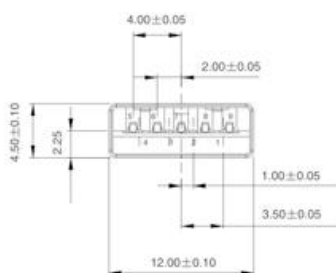
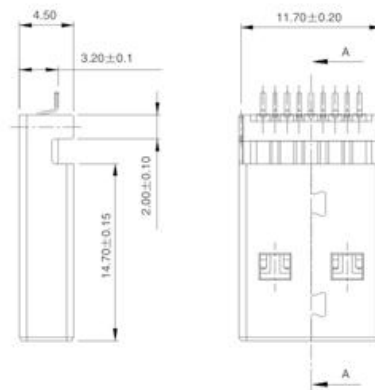
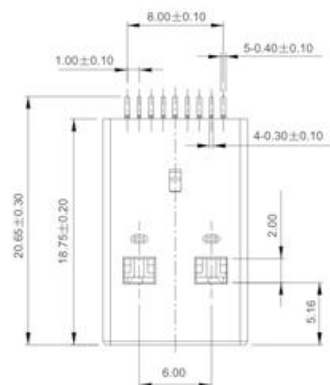

RECOMMENDED PCB LAYOUT

Notes:

- 1) Material:
 Insulator : Thermoplastic G.F. UL94V-0,BULE
 Contacts : Copper Alloy
 Shell : SPCC
- 2) Environmental :-55°C to +105°C
- 3) Electrical:
 Voltage : 30VAC(R.M.S)
 Current Rating : 1.5 Ampere Min.
 Contact resistance : 30Milliohms Max.
 Insulation resistance : 100Megohms Min.
 Dielectric withstanding voltage : 500VAC
- 4) Finish:
 Shell : 50u " min. Nickel
 Contacts : 1~30u " min. Gold on mating area.
 100u " min. Tin on the tails.

USB AF 4P DIP90

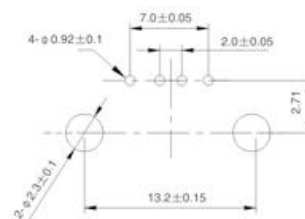
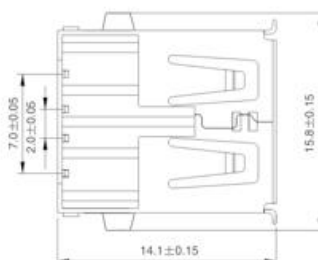
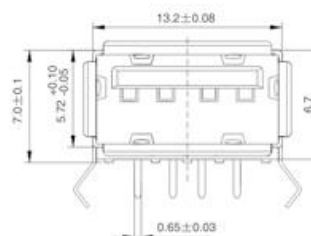
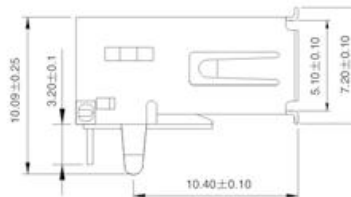

P.C.B. LAYOUT

- ELECTRICAL CHARACTERISTICS:**
 CURRENT-MAX(AMPS) 1.0A
 VOLTAGE-MAX(VOLTS) 30V
 WITHSTANDING VOLTAGE 750V AC
 CONTACT RESISTANCE(OHMS) 30MILLIOHMS MAX
 INSULATION RRESISTANCE(OHMS) 1000 MEGOHMS MIN
 TEMPERATURE RANGE 5°C~+40°C
- MATERIAL:**
 CONTACTS COPPER ALLOY
 INSULATOR PBT+30%G.F. UL 94V-0
 SHELL BRASS
- PLATING:**
 CONTACTS GOLD FLASH AND NICKEL PLATED
 SHELL NICKEL OF TIN PLATED

USB AF 4P SMT

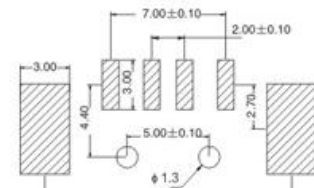
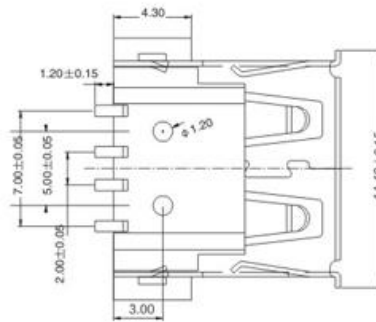
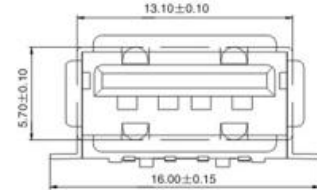
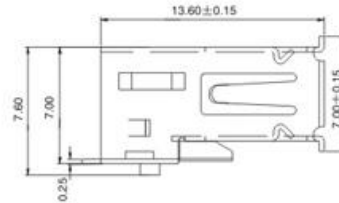

PCB LAYOUT

NOTES:

- Housing: Thermoplastics,UL94V-0
- Contact: Copper Alloy
- Shell: Copper Alloy/Steel
- Voltage Current Rating: 1.5 AMP, 30V AC
- Insulation Resistance: 1000MΩ Min.
- Contact Resistance:30 MΩ Max.
- Dielectric Withstanding Voltage:500W AC
- Temperature Range:-35°C to +85°C
- Insulator color: Black/White
- Plastic material:PBT/LCP,Others
- Sjell finish:Nickel plated/Tin-Lead plated
- Mechanical:
- Mating Force:3.5KG MAX
- Unmatting Force:0.7 KG MIN.

USB AF 4P DIP+SMT SHORT TYPE

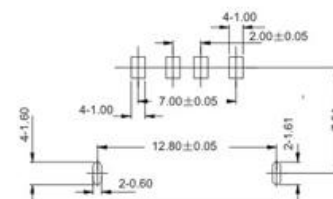
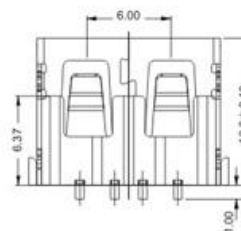
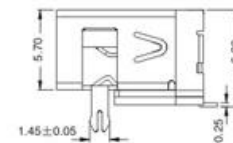
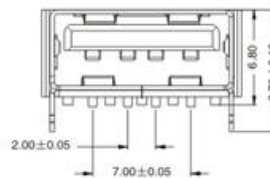
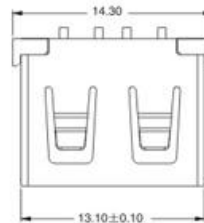

FRONT EDGE OF CONNECTOR
PCB LAYOUT (T=1.60mm)

NOTES:

- 1. HOUSING: SEE NOTES.UL94V-0.
- TERMINAL: SEE NOTES.
- SHELL: SEE NOTES.
- SPECIFICATION:
- 1. ELECTRICAL CHARACTERISTIC:
- CONTACT RESISTANCE: 30MΩ MAX
- DIELECTRIC WITHSTANDING VOLTAGE: 500V AC FOR 1MIN
- INSULATION RESISTANCE: 1000MΩ MIN
- 2. MECHANICAL CHARACTERISTIC:
- INSERTION FORCE: 35N(3.57KGF) MAX
- EXTRACTION FORCE: 10~35(1.02~3.57KGF)MIN
- DURABILITY: 1500 CYCLES EXTRACTION FORCE:10-35N
- 5000 CYCLES MIN
- 5000 CYCLES EXTRACTION FORCE:3~35N
- 3. ENVIRONMENTAL:
- OPERATING TEMPERATURE:-55°C~+85°C

USB 4P FEMALE DIP180 SHORT TYPE

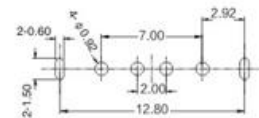
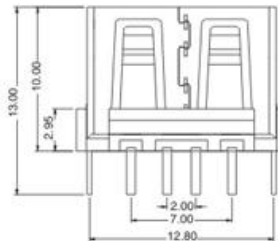
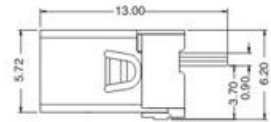
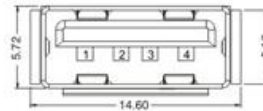
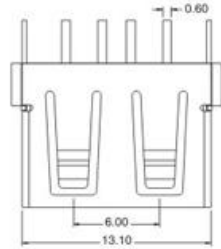

PCB HOLES

Specification:

- 1. Electrical Characteristics:
 - Dielectric Withstanding Voltage: AC 500V/1MINUTE.
 - Insulation Resistance: 1000 MΩ/Min.
 - Contact Resistance: 30 MΩ/Max.
- 2. Mechanical Characteristics:
 - INSERTION FORCE: 30N(3.06KgF)MAX
 - EXTRACTION FORCE: 10~30N(1.02~3.06KgF)
 - Durability: 1500cycles. EXTRACTION FORCE: 10~30N(1.02~3.06KgF)
- 3. Material:
 - Terminal: Phosphor Bronze, C5191/C2680R-EH T=0.25
 - Plating: Gold 0.76 μm Min plating over 1.27 μm Min Nickel underplate, 2.54 μm Min Sn selective plating on solder tail;
 - Shell: Bronze, C2680R-H=0.30mm
 - Plating: Nickel underplate 2.54 μm Min;
 - Housing: LCP Black
- 4. Environmental:
 - Operating Temperature: 0°C to +85°C.

USB AF 4P DIP90 SINKING-BOARD TYPE

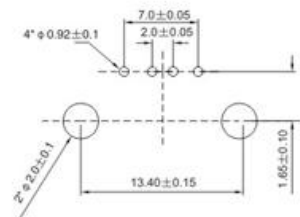
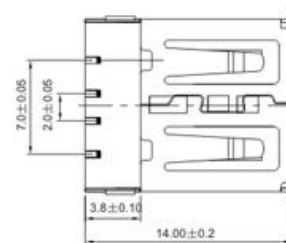
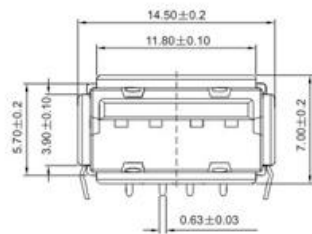
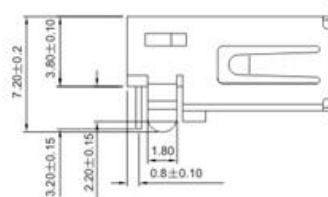

P.C.B. LAYOUT

SPECIFICATION:

- CONTACT CURRENT RATING: 1 AMPERES.
- DIELECTRIC WITHSTANDING VOLTAGE: AC 500V AT SEA LEVEL.
- INSULATION RESISTANCE(OHMS): 1000MΩ MINIMUM.
- CONTACT RESISTANCE: 30MΩ MAX.
- OPERATING TEMPERATURE -55°C TO +850°C
- MATERIAL:
 - CONTACTS COPPER ALLOY
 - INSULATOR PBT+30%G.F. UL94V-0
- MATERIALS:
 - CONTACT: COPPER ALLOY.
 - INSULATOR: THERMOPLASTE P.C.T. UL94V-0.
 - SHELL: COPPER ALLPY.
- MECHANICAL:
 - MATING FORCE: 4.OKG MAX.
 - UNMATING FORCE: 0.7KG MIN.
- FINISHES:
 - CONTACT: GOLD PLATED.
 - SHELL: NICKEL PLATED.

USB 4P FEMALE SINKING-BOARD TYPE

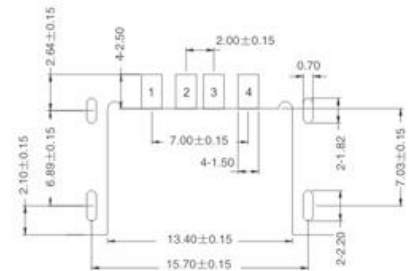
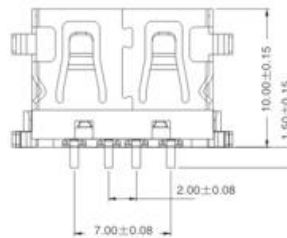
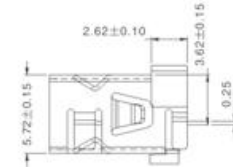
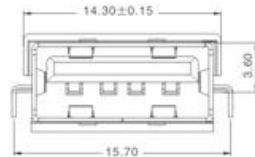
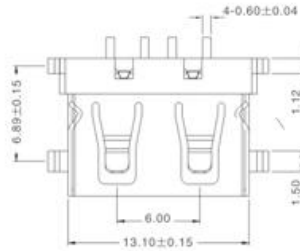

RECOMMENDED PCB LAYOUT
GENERAL TOLERANCES ±0.05

NOTE:

1. Material:
Housing: Thermoplastics, UL94V-0 (ROHS, HF)
Contact: Phosphor Bronze C5191-EH/C2680-EH, T=0.25mm
Shell: COPPER ALLOY T=0.30mm
2. FINISYH:
Contact: 15u" Gold Plated on Contact Area,
80u" Min. Tin Plated on Solder Area,
50u" Min. Nickel Underplating Over All.
Shell: 50u" Min. Nickel Underplating Over All.
3. Specification:
3.1: Rating:
Rated voltage 500V AC/DC. Rated current: 2 A Max.
3.2: Electrical:
Insulation Resistance (EIA-364-21):
1000MΩ Min. at 500V/DC for 1Minute.
Contact Resistance (EIA-364-23):
30mΩ Max. at 20mV Max, 50mA
Dielectric Withstanding Voltage (EIA-364-20):
No discharge, flashover or breakdown at 500V/DC for 1Minute.
4. Plug extraction force shall be between 1.0kgf and 2.00kgf

USB 4P FEMALE SIDE ENTRY SHORT TYPE

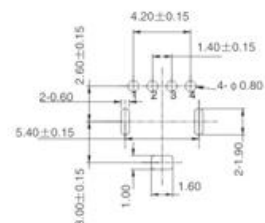
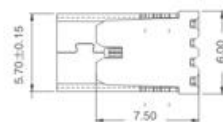
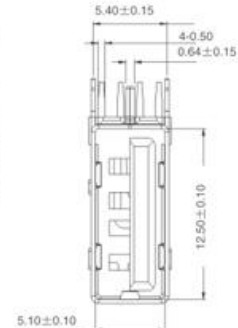
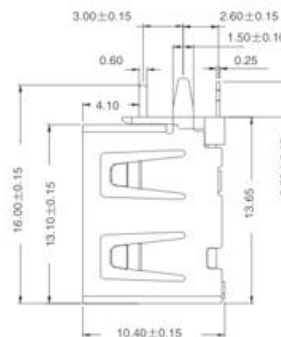
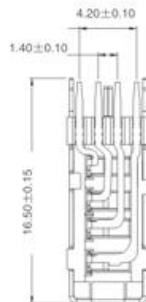
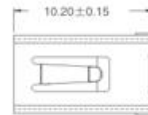

RECOMMENDED PCB LAYOUT
GENERAL TOLERANCES ±0.05

NOTE:

1. Material:
Housing: Thermoplastics, UL94V-0 (ROHS, HF)
Contact: Phosphor Bronze C5191-EH/C2680-EH, T=0.25mm
Shell: COPPER ALLOY T=0.30mm
2. FINISYH:
Contact: 15u" Gold Plated on Contact Area,
80u" Min. Tin Plated on Solder Area,
50u" Min. Nickel Underplating Over All.
Shell: 50u" Min. Nickel Underplating Over All.
3. Specification:
3.1: Rating:
Rated voltage 500V AC/DC. Rated current: 2 A Max.
3.2: Electrical:
Insulation Resistance (EIA-364-21):
1000MΩ Min. at 500V/DC for 1Minute.
Contact Resistance (EIA-364-23):
30mΩ Max. at 20mV Max, 50mA
Dielectric Withstanding Voltage (EIA-364-20):
No discharge, flashover or breakdown at 500V/AC for 1Minute.
4. Plug extraction force shall be between 1.0kgf and 2.00kgf

USB 8P FEMALE DIP90 DOUBLE SIDE INSERT TYPE

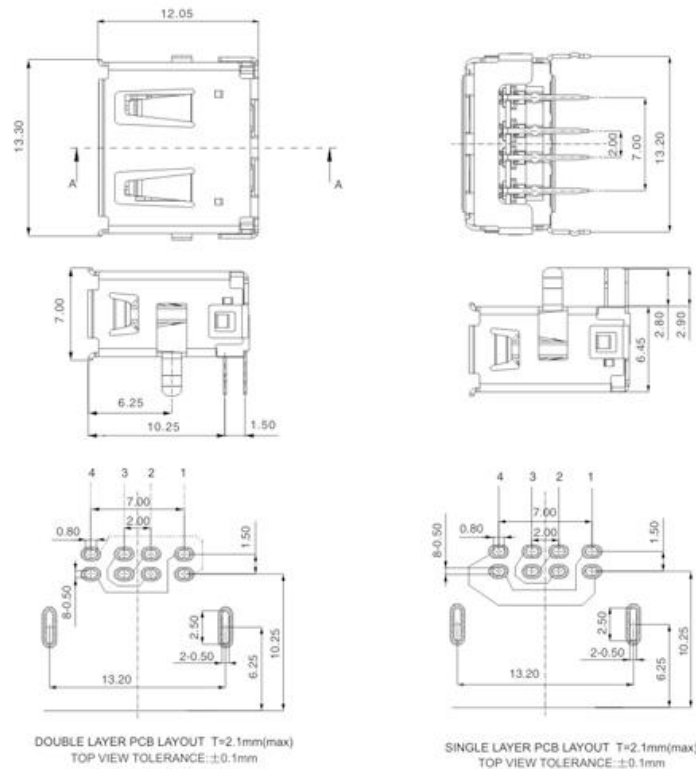

NOTES:

1.MATERIAL:

- 1.1 HOUSING:THERMOPLASTIC COLOR:BLACK
- 1.2 CONTACT: COPPER ALLOY
- 1.3 SHELL: STAINLESS OR K7

2.PLATING:

CONTACT:

- 1). GOLD FLASH CONTACT AREA ;120u" TIN SOLDER;NICKEL OVER ALL
- 2). 5u" GOLD CONTACT AREA ;120u" TIN SOLDER;NICKEL OVER ALL
- 3). 15u" GOLD CONTACT AREA ;120u" TIN SOLDER;NICKEL OVER ALL

3.SHELL: NICKEL OVER ALL

4.ENVIRONMENTAL:

OPERATION TEMPERATURE:-40°C~+85°C

USB 8P FEMALE DIP180 DOUBLE SIDE INSERT TYPE

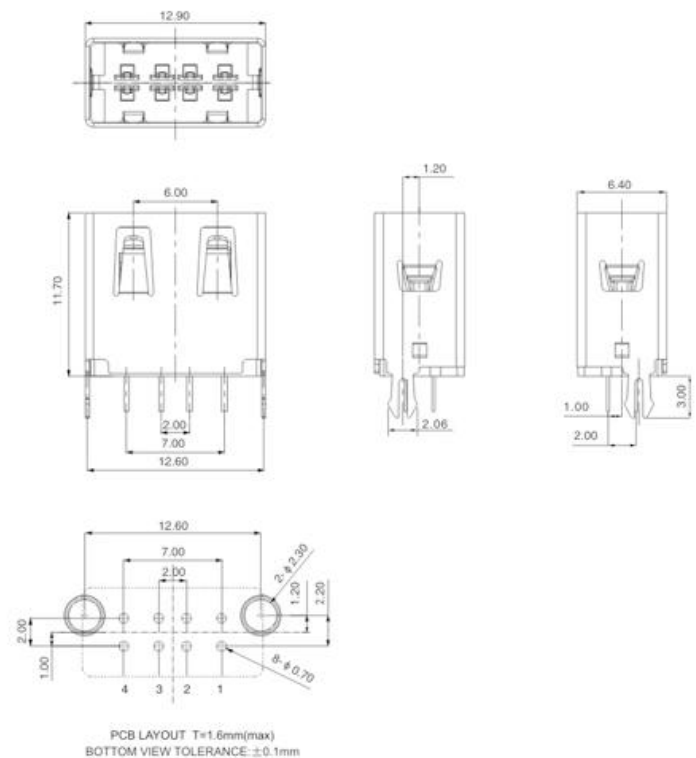

NOTES:

1.MATERIAL:

- 1.1 HOUSING:THERMOPLASTIC COLOR:BLACK
- 1.2 CONTACT: COPPER ALLOY

2. PLATING:

CONTACT:

- 1). GOLD FLASH CONTACT AREA ;120u" TIN SOLDER;NICKEL OVER ALL
- 2). 5u" GOLD CONTACT AREA ;120u" TIN SOLDER;NICKEL OVER ALL
- 3). 15u" GOLD CONTACT AREA ;120u" TIN SOLDER;NICKEL OVER ALL

3.ENVIRONMENTAL:

OPERATION TEMPERATURE:-40°C~+85°C

4.PRODUCT COMPLIANT TO THE REQUEST OF RoHS

DUAL USB AF 8P DIP90

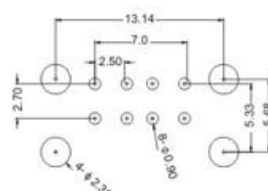
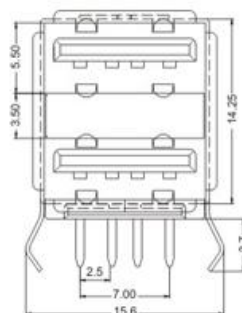
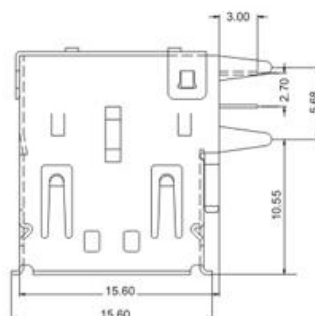
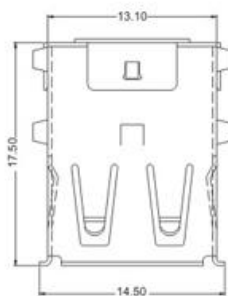

PCB LAYOUT

Specifications:

Electrical:

- Contact Resistance 30 milliohms MAX
- Dielectric Withstanding Voltage: 500V AC AT Sea Level
- Insulation Resistance: 1000 MEGA ohms MIN

Mechanical:

- Mating Force: 3.5 KG MAX
- Unmating Force: 0.7 KG MIN.

DUAL USB 8P FEMALE DIP90 REVERSE

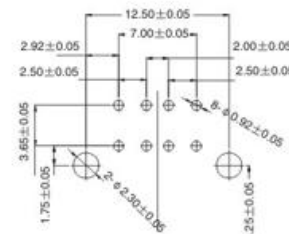
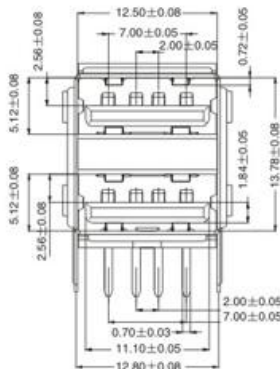
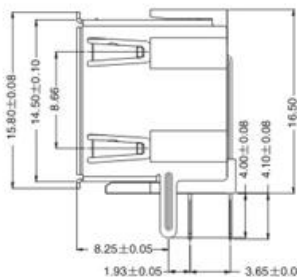
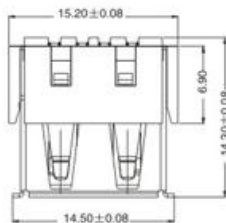

PCB LAYOUT

NOTE:

1. Material:
 - Housing: Thermoplastics.PBT
 - Contact: Phosphor Bronze C2680-EH, T=0.25mm
 - Shell: SPCC T=0.30mm
2. FINISH:
 - Contact: 3u" Gold Plated on Contact Area, 80u" Min. Tin Plated on Solder Area, 50u" Min. Nickel Underplating Over All.
 - Shell: 50u" Min. Nickel Underplating Over All.
3. Specification:
 - 3.1: Rating:
 - Rated voltage 500V AC/DC. Rated current: 2 A Max.
 - 3.2: Electrical:
 - Insulation Resistance(EIA-364-21): 1000MΩ Min. at 500V/DC for 1Minute.
 - Contact Resistance(EIA-364-23): 30mΩ Max. at 20mV Max, 50mA
 - Dielectric Withstanding Voltage(EIA-364-20): No discharge, flashover or breakdown at 500V/AC for 1Minute.
4. Plug extraction force shall be between 1.0kgf and 2.00kgf

USB 10P FEMALE DIP+SMT

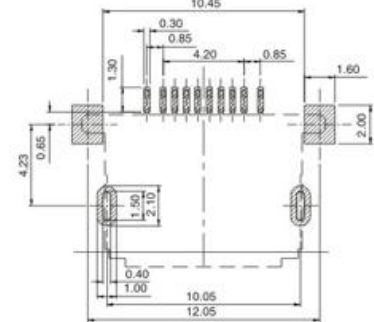
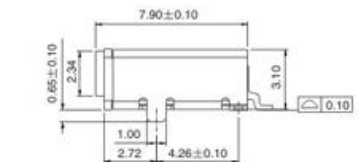
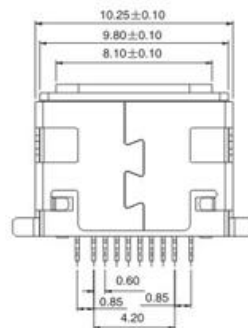
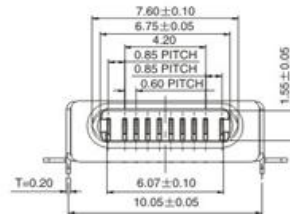
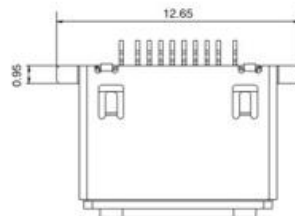

RECOMMEND PCB LAYOUT
GFNFRAL TOLFRANCF ±0.05

NOTES:

- 1.MATERIAL AND FINISH:
CONTACTS:COPPPER ALLOR,GOLD FLASH OVER ALL;
LATCH:STAINLESS;
SHELL:STAINLESS,GOLD FLASH ON SOLDER TAILS;
HOUSING:THERMOPLASTIC,BLACK;
- 2.THE RETENTION FORCE OF PIN IS SET TO 200gf MIN.
- 3.INSERTION FORCE:2.0gf MAX, EXTRACTION FORCE;0.80gf
MIN INITAL,0.40gf MIN AFTER 10000 CYCLES.
- 4.THERE SHOULD BE NO DBVIOUS BUBBLE UNDER THE
TAPE AND FLOAT AREA.

APPLE 30P FEMALE SMT

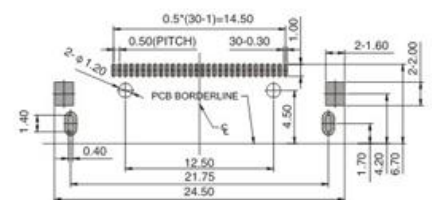
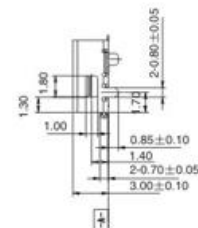
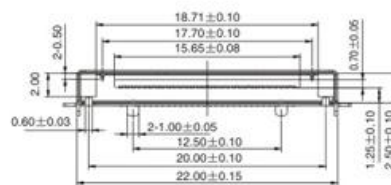
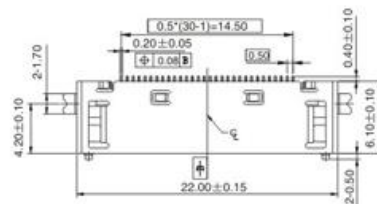
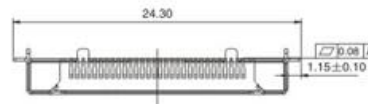

PCB LAYOUT

NOTES:

- 1.MATERIAL AND FINISH:
CONTACTS:COPPPER ALLOR,GOLD FLASH OVER ALL;
LATCH:STAINLESS;
SHELL:STAINLESS,GOLD FLASH ON SOLDER TAILS;
HOUSING:THERMOPLASTIC,BLACK;
- 2.THE RETENTION FORCE OF PIN IS SET TO 200gf MIN.
- 3.INSERTION FORCE:2.0gf MAX, EXTRACTION FORCE;0.80gf
MIN INITAL,0.40gf MIN AFTER 10000 CYCLES.
- 4.THERE SHOULD BE NO DBVIOUS BUBBLE UNDER THE
TAPE AND FLOAT AREA.

MICRO USB 5P FEMALE B TYPE SMT

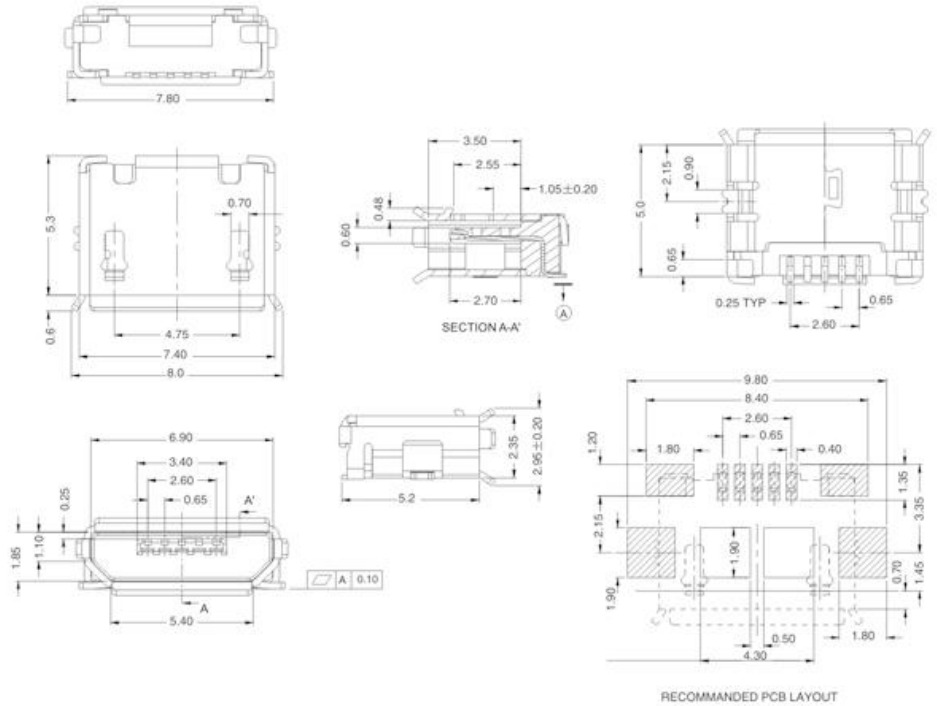

Specifications:

1. Current rating: 1A Max.
2. Dielectric withstanding:voltage: 100V(AC) for 1 min.
3. Contact resistance: 50mΩ Max.
4. Insulation resistance: 100MΩ Min.
5. Total mating force: 3.57 Kgf Max.
6. Total unmating force: 1.0 Kgf Min,0.81~2.05 Kgf Min,after 10000 insertion/extraction cycles
7. Temperature range: -30℃~+80℃

MICRO USB 5P FEMALE 5.5DIP+SMT

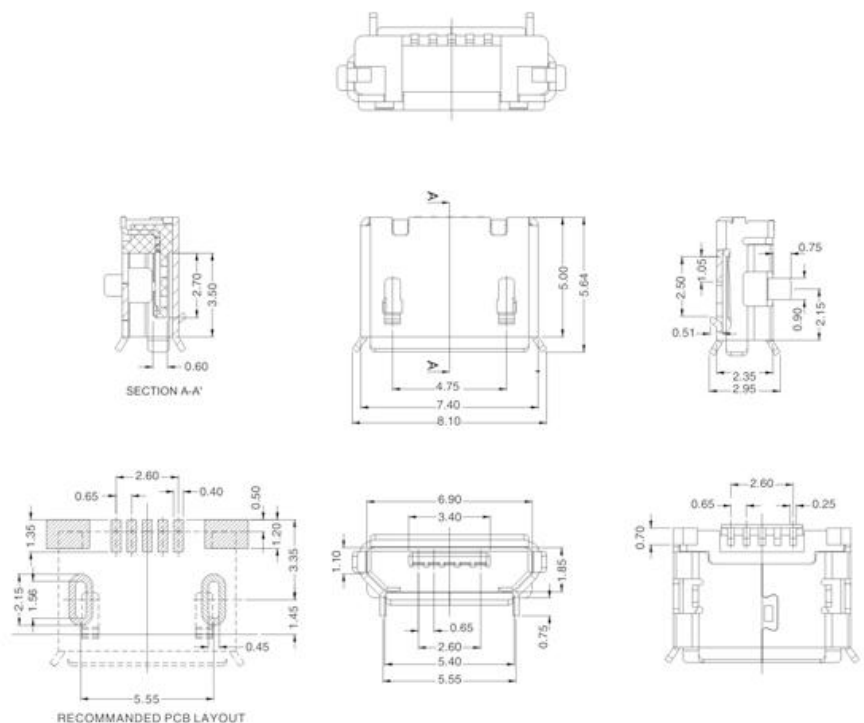

Notes:

1. Material:
 - 1.1 Housing: High temperature thermoplastic with g.f UL94V-0.
 - 1.2 Contact: copper alloy, t=0.20mm.
 - 1.3 Shell: copper alloy, t=0.25mm
2. Specifications:
 - 2.1 Current rating: 1A Max.
 - 2.2 Dielectric withstanding:voltage: 100V(ac) for 1 min.
 - 2.3 Contact resistance: 50 mW Max.
 - 2.4 Insulation resistance: 100 MW Min.
 - 2.5 Total mating force: 3.57 Kgf Max.
 - 2.6 Total unmating force:1.0 Kgf Min,0.81~2.05 Kgf Min,after 10000 insertion/extraction cycles
 - 2.7 Temperature range: -30℃~+80℃

MICRO USB 5P FEMALE DIP

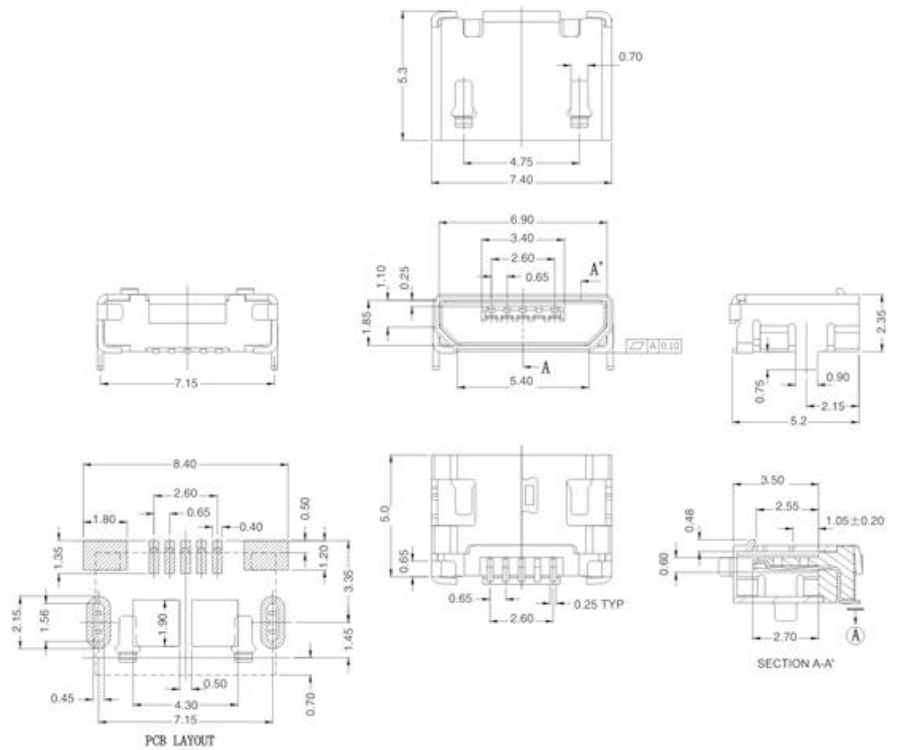
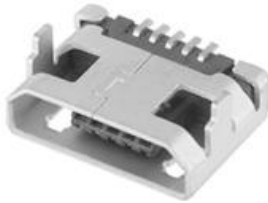

Notes:

1. Materials:

- 1.1 Contact: copper alloy, t=0.20mm.
- 1.2 Shell: copper alloy, t=0.25mm.
- 1.3 Housing: High temperature thermoplastic with g.f UL94V-0.

2. Specifications:

- 2.1 Current rating: 1A Max.
- 2.2 Dielectric withstanding:voltage: 100V(ac) for 1 min.
- 2.3 Contact resistance: 50 mW Max.
- 2.4 Insulation resistance: 100 MW Min.
- 2.5 Total mating force: 3.57 Kgf Max.
- 2.6 Total unmating force:1.0 Kgf Min.0.81~2.05 Kgf Min.after 10000 insertion/extraction cycles
- 2.7 Temperature range: -30°C+80°C

MICRO USB 5P FEMALE 7.2DIP

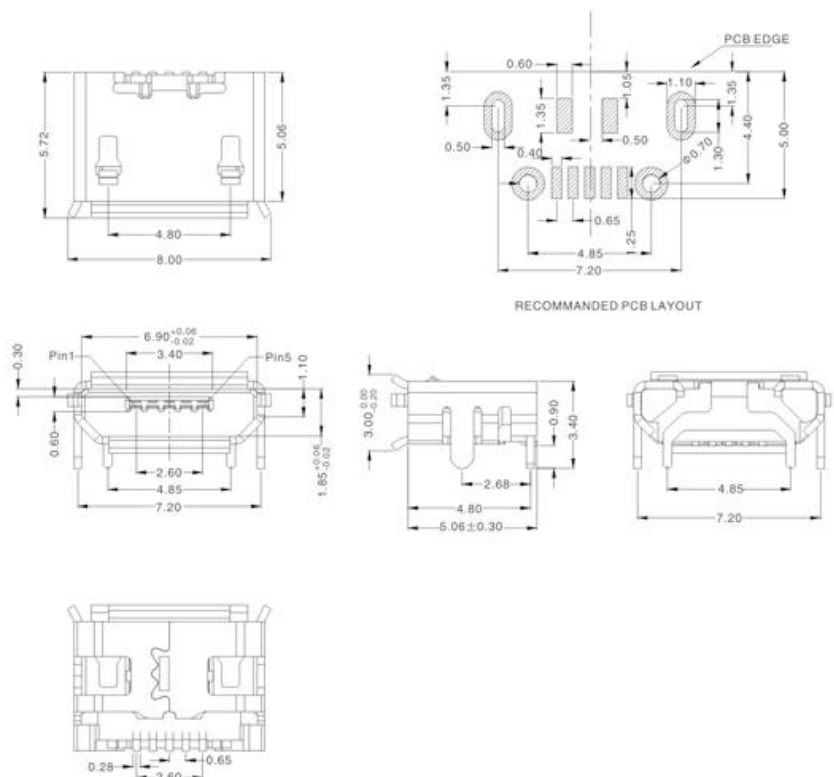

Notes:

1. Material:

- 1.1 Housing: High temperature thermoplastic with g.f. UL94V-0.
- 1.2 Contact: copper alloy,t=0.15mm.
- 1.3 Shell: copper alloy,t=0.30mm.

2. Specifications:

- 2.1 Current rating: 1A Max.
- 2.2 Dielectric withstanding:voltage: 100V(AC) for 1 min.
- 2.3 Contact resistance: 50 mW Max.
- 2.4 Insulation resistance: 100 MW Min.
- 2.5 Total mating force: 3.57 Kgf Max.
- 2.6 Total unmating force:1.0 Kgf Min.0.81~2.05 Kgf Min.after 10000 insertion/extraction cycles
- 2.7 Temperature range: -30°C~80°C

MICRO USB 5P FEMALE SMT CONVEX CLOSURE TYPE

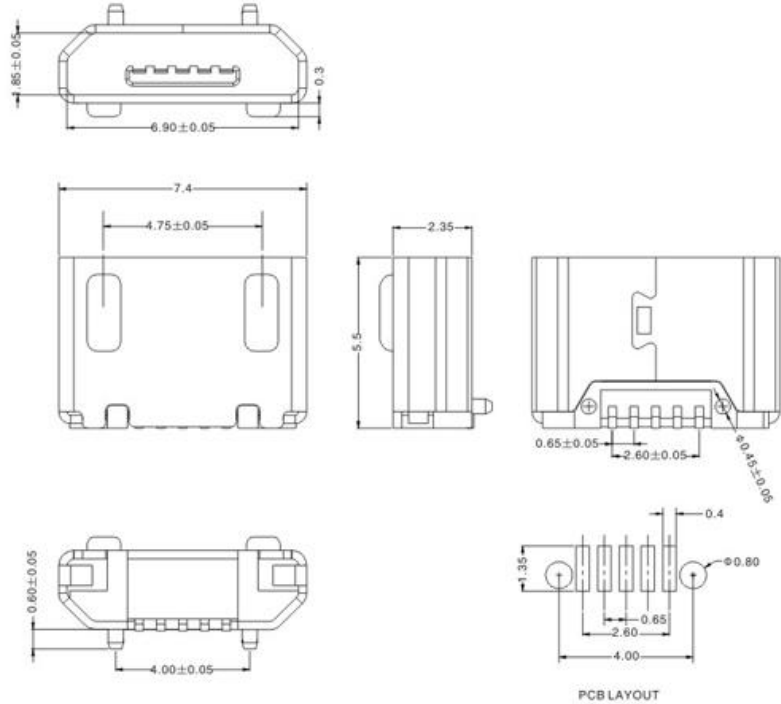

Notes:

1. Material:

- 1.1 Housing: High temperature thermoplastic with g.f UL94V-0.
- 1.2 Contact: copper alloy, t=0.20mm.
- 1.3 Shell: copper alloy, t=0.25mm

2. Specifications:

- 2.1 Current rating: 1A Max.
- 2.2 Dielectric withstanding:voltage: 100V(ac) for 1 min.
- 2.3 Contact resistance: 50 mW Max.
- 2.4 Insulation resistance: 100 MW Min.
- 2.5 Total mating force: 35N Max.
- 2.6 Total unmating force:10N Min.INITAL 8-20N after 3000 cycles
10000 insertion/extraction cycles
- 2.7 Temperature range: -30°C +80°C

MICRO USB 5P FEMALE REVERSE DIP

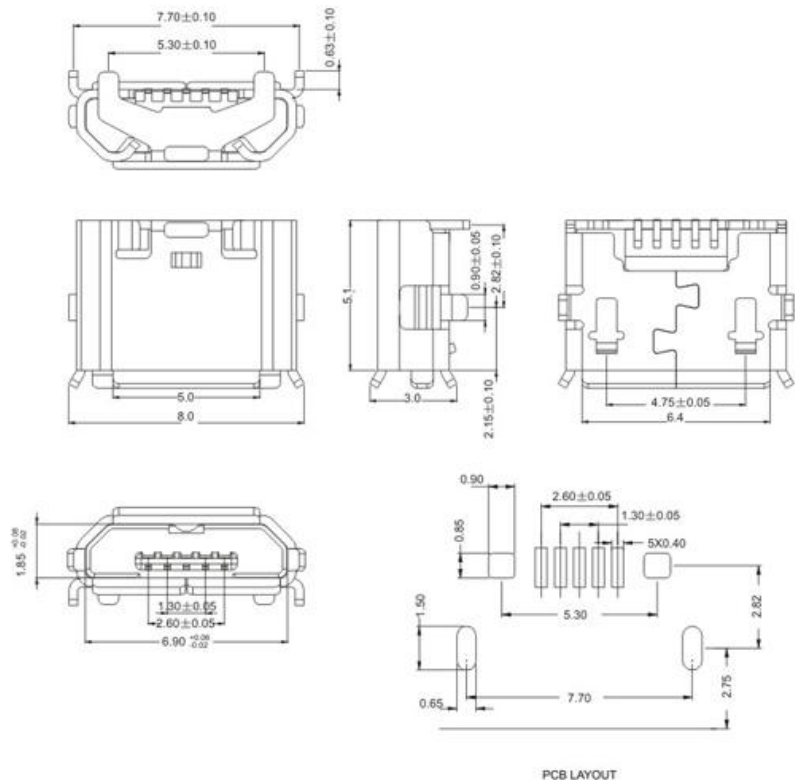

Notes:

1. Material:

- 1.1 Housing: High temperature thermoplastic with g.f UL94V-0.
- 1.2 Contact: copper alloy, t=0.15mm.
- 1.3 Shell: copper alloy & SUS

2. Specifications:

- 2.1 Current rating: 1A Max.
- 2.2 Dielectric withstanding:voltage: 100V(ac) for 1 min.
- 2.3 Contact resistance: 30m Ω Max.
- 2.4 Insulation resistance: 100 M Ω Min.
- 2.5 Total mating force: 3.57 Kgf Max.
- 2.6 Total unmating force:1.0 Kgf Min.0.81~2.05 Kgf Min.after
3000 insertion/extraction cycles
- 2.7 Temperature range: -30°C~+80°C

MICRO USB 5P FEMALE SINKING-BOARD TYPE 0.7DIP

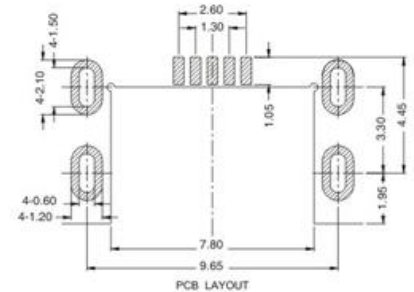
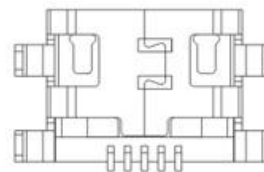
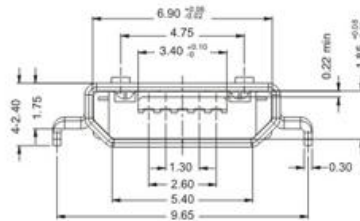
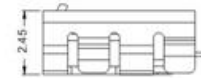
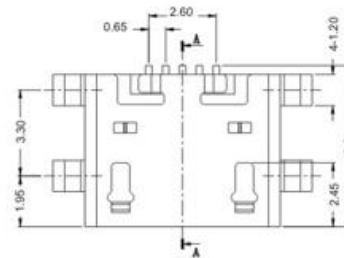

Notes:

1. Materials:

- 1.1 Housing: High temperature thermoplastic UL94V-0, BLACK.
- 1.2 Contact: copper alloy.
- 1.3 Shell: copper alloy.

2. Specifications:

- 2.1 Current rating: 0.5A Max.
- 2.2 Dielectric withstanding: voltage: 100V(AC) for 1 min.
- 2.3 Contact resistance: 50mΩ Max.
- 2.4 Insulation resistance: 100 MΩ Min.
- 2.5 Total mating force: 3.57 Kgf Max.
- 2.6 Total unmating force: 1.0 Kgf Min. 0.81~2.05 Kgf Min. after 10000 insertion/extraction cycles
- 2.7 Temperature range: -30°C~+80°C

MICRO USB 5P FEMALE SINKING-BOARD TYPE 1.17SMT

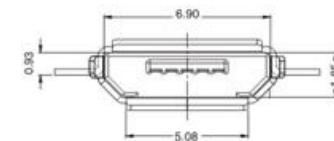
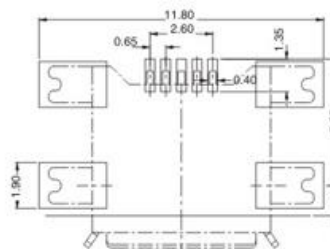
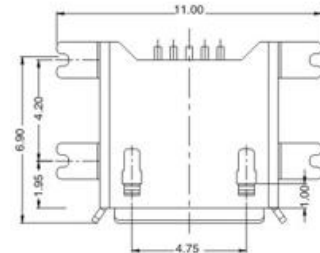

P.C.B. LAYOUT

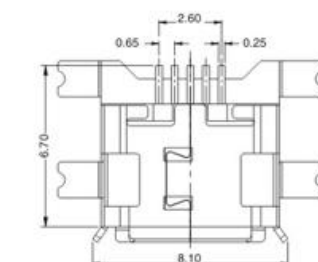

Notes:

1. Materials:

- 1.1 Housing: High temperature thermoplastic with g.f. UL94V-0.
- 1.2 Contact: copper alloy, t=0.20mm.
- 1.3 Shell: copper alloy, t=0.25mm.

2. Specifications:

- 2.1 Current rating: 1A Max.
- 2.2 Dielectric withstanding: voltage: 100V(AC) for 1 min.
- 2.3 Contact resistance: 50 mW Max.
- 2.4 Insulation resistance: 100 MW Min.
- 2.5 Total mating force: 3.57 Kgf Max.
- 2.6 Total unmating force: 1.0 Kgf Min. 0.81~2.05 Kgf Min. after 10000 insertion/extraction cycles
- 2.7 Temperature range: -30°C~+80°C

MICRO USB 5P FEMALE SINKING-BOARD TYPE 1.6DIP+SMT

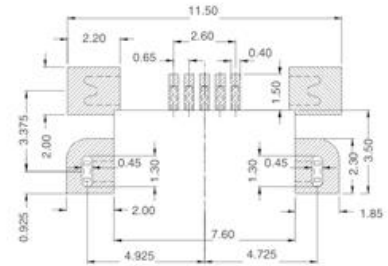
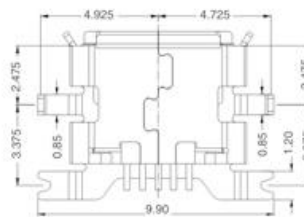
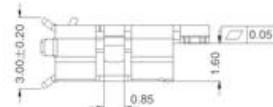
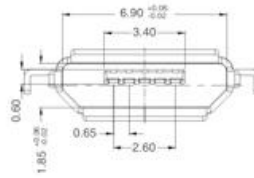
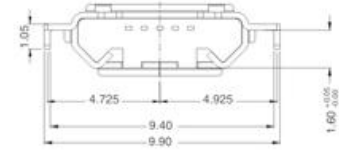
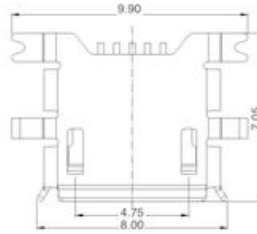

RECOMMANDEE PCB LAYOUT

Notes:

1. Material:

- 1.1 Contact: copper alloy, t=0.20mm.
- 1.2 Shell: copper alloy, t=0.25mm.
- 1.3 Housing: High temperature thermoplastic with g.f UL94V-0.

2. Specifications:

- 2.1 Current rating: 1A Max.
- 2.2 Dielectric withstanding:voltage: 100V(ac) for 1 min.
- 2.3 Contact resistance: 50 mΩ Max.
- 2.4 Insulation resistance: 100 MΩ Min.
- 2.5 Total mating force: 3.57 Kgf Max.
- 2.6 Total unmating force:1.0 Kgf Min.0.81~2.05 Kgf Min.after 10000 insertion/extraction cycles
- 2.7 Temperature range: -30°C~+80°C

MICRO USB 5P FEMALE VERTICAL ENTRY TYPE

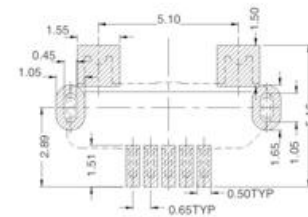
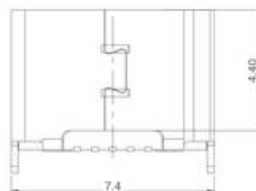
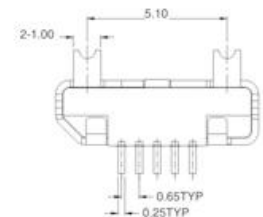
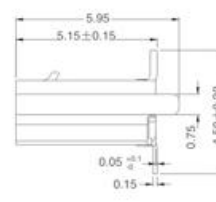
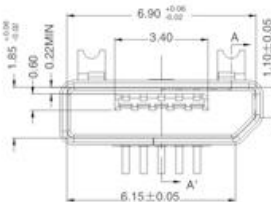
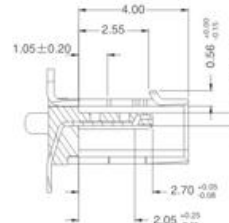
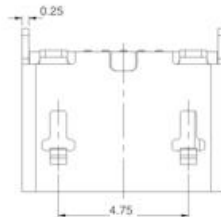

RECOMMANDEE PCB LAYOUT

Notes:

Specifications:

- 1 Current rating: 1A Max.
- 2 Dielectric withstanding:voltage: 100V(ac) for 1 min.
- 3 Contact resistance: 50 mΩ Max.
- 4 Insulation resistance: 100 MΩ Min.
- 5 Total mating force: 3.57 Kgf Max.
- 6 Total unmating force: 1.0 Kgf Min.0.81~2.05 Kgf Min.after 10000 insertion/extraction cycles
- 7 Temperature range: -30°C~+80°C

MICRO USB 5P FEMALE WATERPROOF TYPE

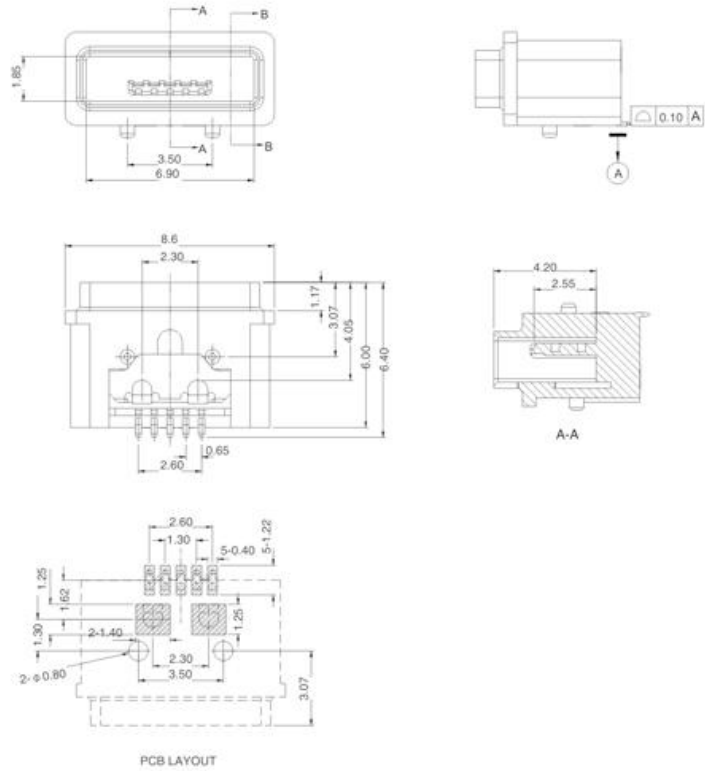

Notes:

1. Materials:

- 1.1 Housing: High temperature thermoplastic UL94V-0, BLACK.
- 1.2 Contact: copper alloy.
- 1.3 Shell: SUS.

2. Specifications:

- 2.1 Current rating: 0.5A Max.
- 2.2 Dielectric withstanding: voltage: 100V(AC) for 1 min.
- 2.3 Contact resistance: 50mΩ Max.
- 2.4 Insulation resistance: 100 MΩ Min.
- 2.5 Total mating force: 3.57 Kg Max.
- 2.6 Total unmating force: 1.02 Kg Min. 0.81Kg Min. after 3000 insertion/extraction cycles
- 2.7 Temperature range: -30°C to +80°C

MICRO USB 5P FEMALE WATERPROOF SINKING-BOARD TYPE

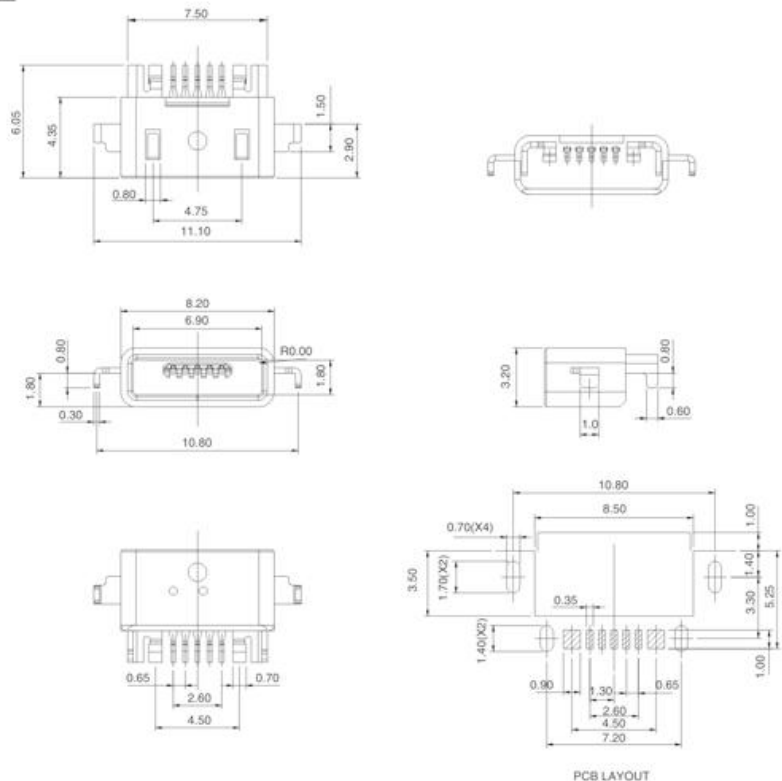

Specification:

- 1. Current Rating: 1.0AMP
- 2. Voltage Rating: 30V AC,DC
- 3. Dielectric Strength: 500V AC RMS for 1 minute.
- 4. Contact Resistance: 30 mΩ Max.
- 5. Insulation Resistance: 500 MΩ Min. AT 250V DC.
- 6. Mating/Unmating cycles: 2000cycles
- 7 Temperature : -20°C to +60°C

MICRO USB 3.0 FEMALE DIP

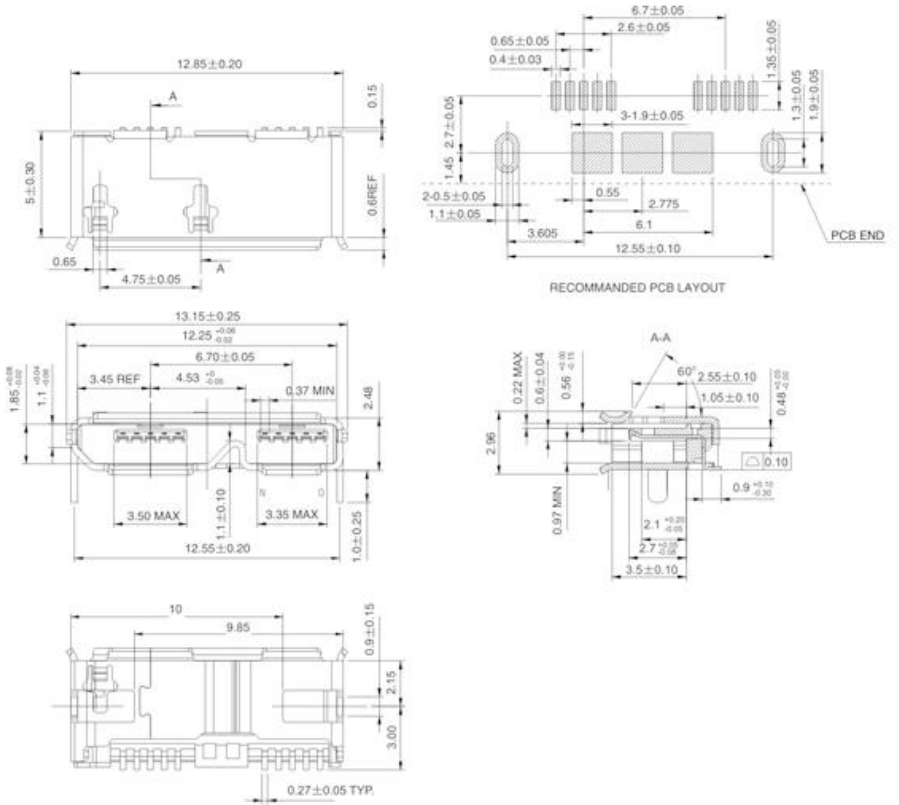
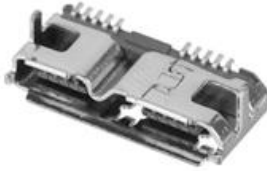

NOTES:

1. INSULATOR:LCP COLOR-BLACK
2. USB CONTACT: BRASS,0.15mm THICKNESS, GOLD PLATED ON CONTACT AREA, GOLD FLASH OR 50 U " TIN PLATED OVERALL. 80U " MIN. NICKEL UNDER PLATED OVERALL.
3. SHELL: STAINLESS STEEL ,0.3 THICKNESS, 40U " NICKEL PLATED ON THE SOLDERING TAB.
4. ELECTRICAL CHARACTERISTICS:
 - 4.1 CONTACT RESISTANCE:30mΩ MAXIMUM
 - 4.2 CONTACT CURRENT RATING:1.5AMPERES
 - 4.3 DIELECTRIC WITHSTANDING VOLTAGE: 100V R.M.S.
 - 4.4 INSULATION RESISTANCE 100MΩ MIN
 - 4.5 OPERATING TEMPERATURE:-40°C~85°C
5. MECHANICAL CHARACTERISTICS:
 - 5.1 MATING FORCE:35N MAX
 - 5.2 UNMATING FORCE:10N MIN(INITIAL)
8N MIN(10000 CYCLES AFTER)
 - 5.3 DURABILITY: 10000CYCLES MIN

MICRO USB 3.0 FEMALE SINKING-BOARD TYPE

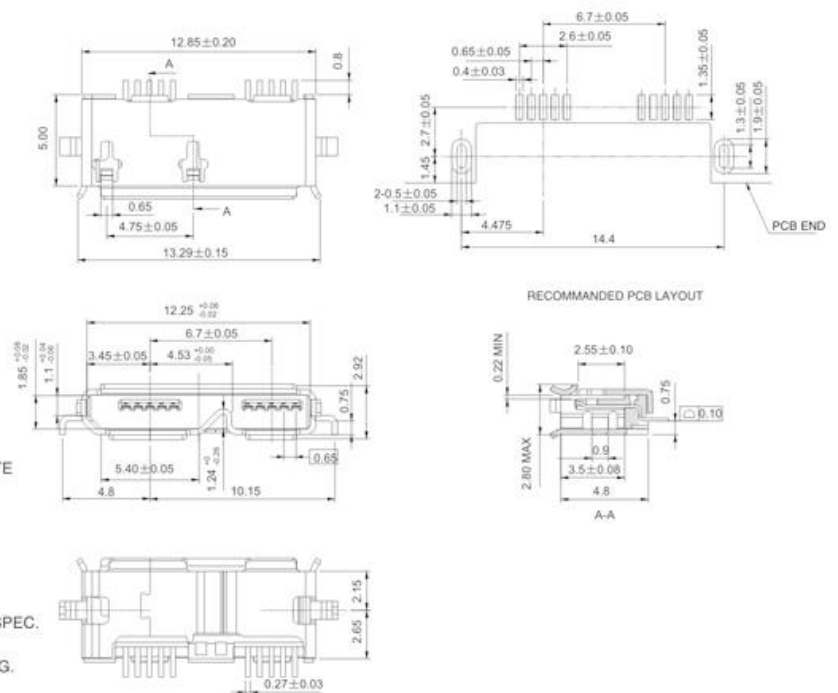

SPECIFICATIONS:

1. ELECTRICAL CHARACTERISTICS:
 - 1-1. CONTACT RESISTANCE: 30mΩ MAX.
 - 1-2. DIELECTRIC WITHSTANDING VOLTAGE: 500V AC FOR 1 MINUTE
 - 1-3. INSULATION RESISTANCE: 100MΩ MIN.
2. MECHANICAL CHARACTERISTICS:
 - 2-1. INSERTION FORCE : 3.5 Kgf MAX
 - 2-2. WITHDRAWAL FORCE: 1.0 Kgf MIN
3. DURABILITY: 10,000 CYCLES.
4. OTHER SPEC TO REFER USB 3.0 SPEC.
5. TO CONFORM TO SINGATRON HAZZARDOUS SUBSTANCE FREE SPEC.
6. HALOGEN FREE PRODUCT IDENTIFICATION MARK.
7. HALOGEN FREE PRODUCT IDENTIFICATION LABEL ON PACKAGING.
8. FOR REFLOW SOLDERING LEAD-FREE PROCESS.
9. PACKAGING: TAPE & REEL.

MICRO USB 3.0 FEMALE VERTICAL ENTRY TYPE

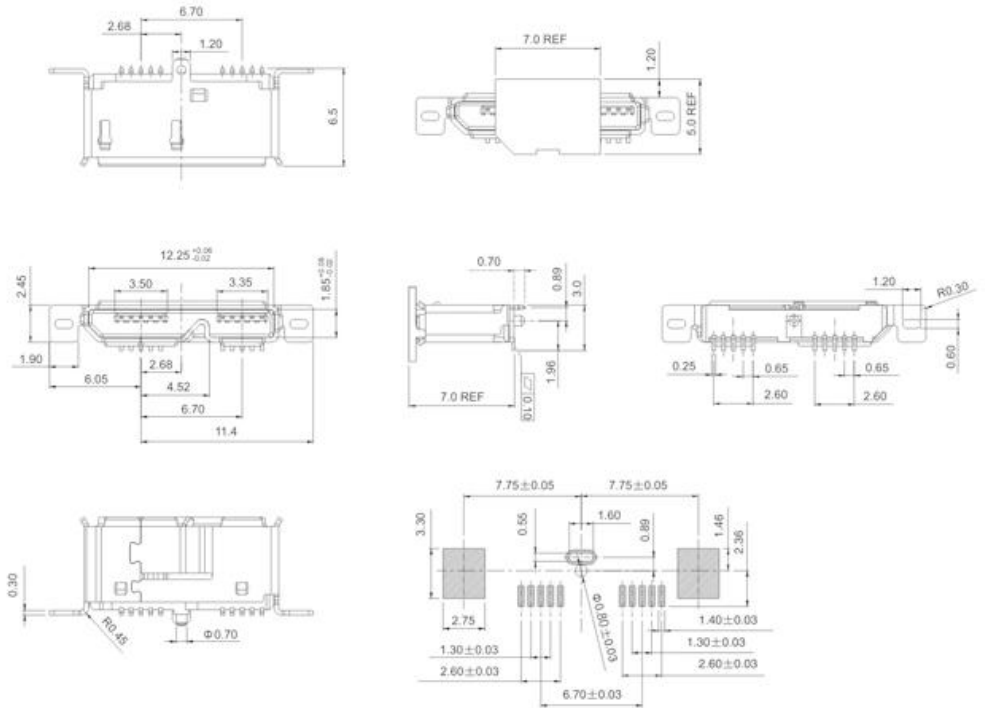

Notes:

- 1) Material:
 Insulator: Thermoplastic G.F.UL94V-0
 Contacts: Copper Alloy
 Shell : Metal
- 2) Environmental:
 -55°C to +105°C
- 3) Finish:
 Shell : 50u"min. Solderable Ni
 Contacts: 1'30u" min. Gold on mating area.
 100u" min. Tin on the tails.

RECOMMENDED PCB LAYOUT

MINI USB 5P FEMALE SMT

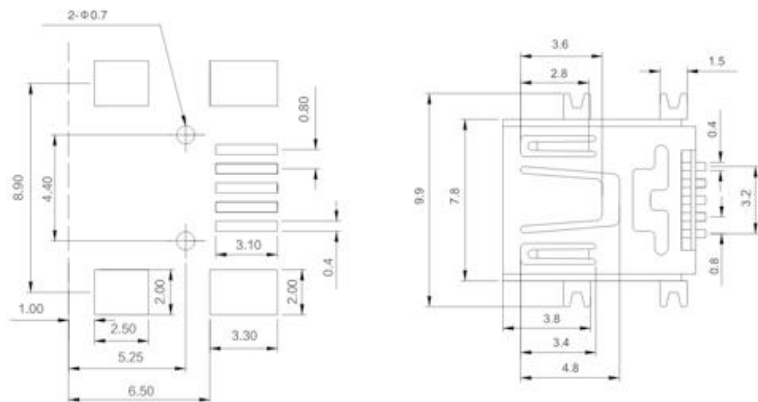

PCB LAYOUT

Electrical:

- Current-max[amps]: 1.0A
- Voltage-max[volts]: 30V
- Withstanding Voltage: 100V AC
- Contact Resistance[ohms]: 50 milliohms max
- Insulation Resistance[ohms]: 100 Megohms min
- Temperature Range: 0°C to +105°C

Material:

- Contact: Phorphos Bronze
- Insulator: LCP UL94V-0
- Shell: Brass

Plating:

- Contacts: Gold And Tin Plating
- Shell: Tin Plating

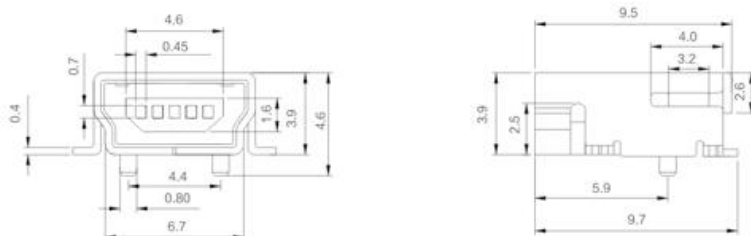

MINI USB 5P FEMALE DIP180

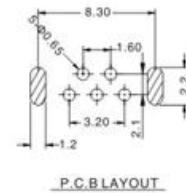
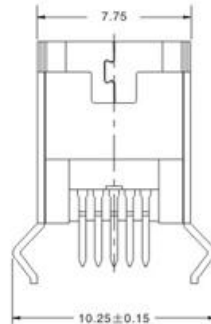
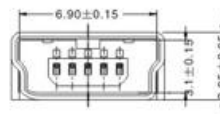
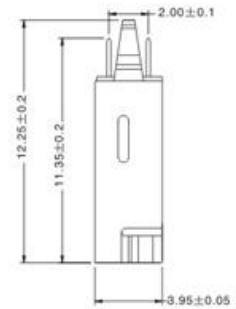
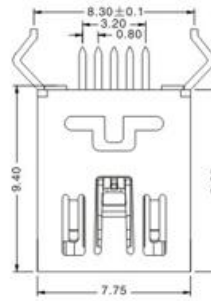

Notes:

1. Material:

- 1.1 Insulator: High temperature thermplastic with g.f.UL94v-0
- 1.2 Contact: Phosphor bronze, t=0.25mm
- 1.3 Shell: Phosphor bronze, t=0.40mm

2. Specifications:

- 2.1 Current rating: 1A Max.
- 2.2 Dielectric withstanding:
voltage: 750V(AC) for 1 min.
- 2.3 Contact resistance: 30mW Max.
- 2.4 Insulation resistance: 1000 MW Min.
- 2.5 Total mating force: 3.0 Kgf Max.
- 2.6 Total unmating force: 0.5 Kgf Min.
- 2.7 Temperature range: -55°C-85°C

MINI USB 12P FEMALE SMT

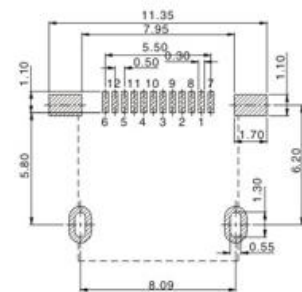
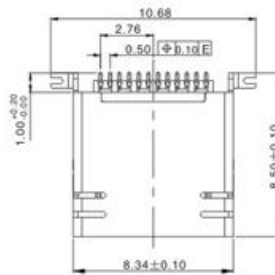

RECOMMENDED P.C.B LAYOUT
TOLERANCE: ±0.05 TOP VIEW

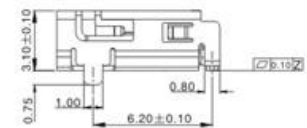
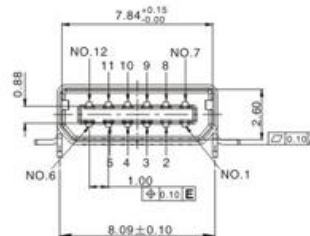

Notes:

1. Material:

- 1.1 Insulator: High temperature thermplastic with g.f.UL94v-0
- 1.2 Contact: Phosphor bronze, t=0.25mm
- 1.3 Shell: Phosphor bronze, t=0.40mm

2. Specifications:

- 2.1 Current rating: 1A Max.
- 2.2 Dielectric withstanding:
voltage: 750V(AC) for 1 min.
- 2.3 Contact resistance: 30mW Max.
- 2.4 Insulation resistance: 1000 MW Min.
- 2.5 Total mating force: 3.0 Kgf Max.
- 2.6 Total unmating force: 0.5 Kgf Min.
- 2.7 Temperature range: -55°C-85°C

CPJ2512

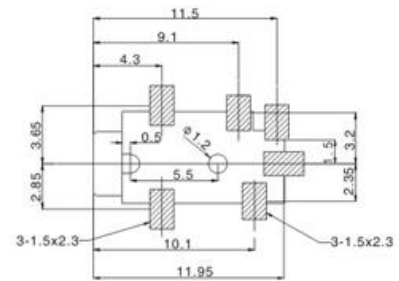
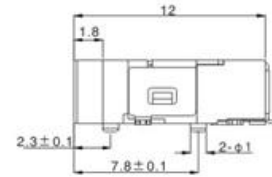
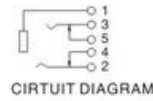
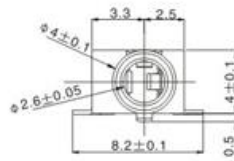
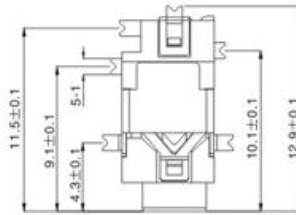

PCB LAYOUT TOP VIEW

SPECIFICATION

1. Rating: DC 30V 0.5A;
2. Contact resistance: $\leq 0.03\Omega$;
3. Insulation resistance: $\geq 100M\Omega$ (DC250V);
4. Withstand voltage: 500VAC;
5. Insertion and extraction force: 3-20N;
6. life test: 5,000 cycles;

CPJ2537

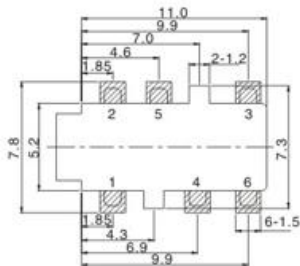
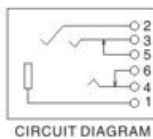
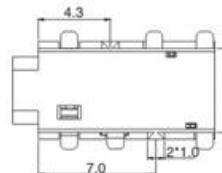
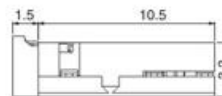
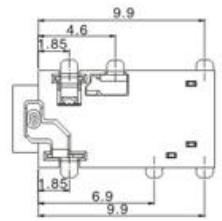

PCB LAYOUT TOP VIEW

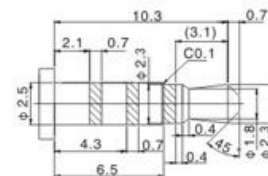
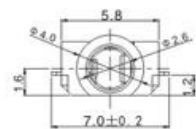
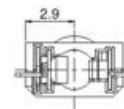

Mate Plugs Dimensions

SPECIFICATION

1. Rating: DC 30V 0.5A;
2. Contact resistance: $\leq 0.03\Omega$;
3. Insulation resistance: $\geq 100M\Omega$ (DC250V);
4. Withstand voltage: 500VAC;
5. Insertion and extraction force: 3-20N;
6. life test: 5,000 cycles;

CPJ2570001

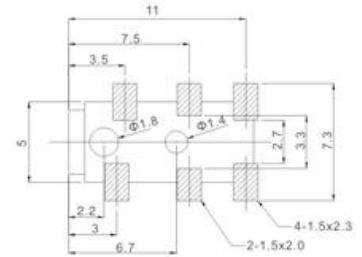
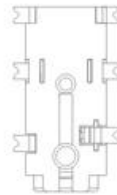
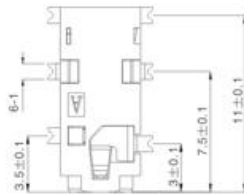

PCB LAYOUT TOP VIEW

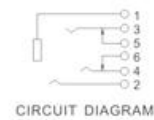
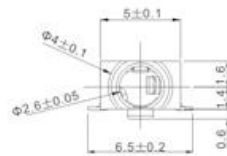

CIRCUIT DIAGRAM

SPECIFICATION

1. Rating: DC 30V 0.5A;
2. Contact resistance: $\leq 0.03\Omega$;
3. Insulation resistance: $\geq 100M\Omega$ (DC250V);
4. Withstand voltage: 500VAC;
5. Insertion and extraction force: 3-20N;
6. life test: 5,000 cycles;

CPJ320DS

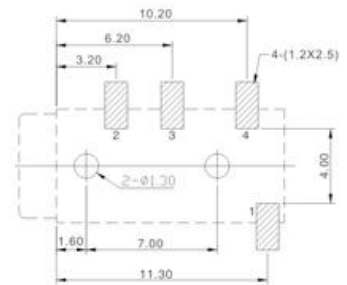
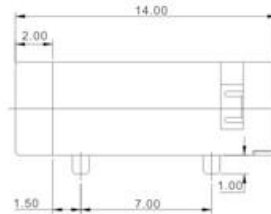
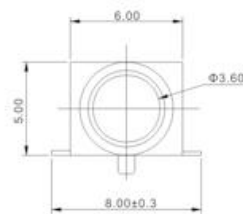

P.C.B. LAYOUT TOP VIEW

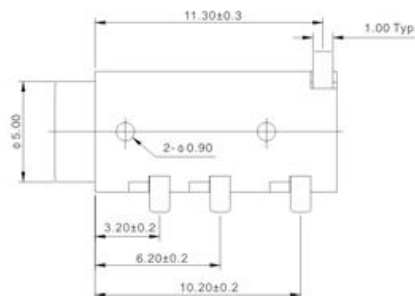

SCHEMATIC

SPECIFICATION

1. Rating: DC 30V 0.5A;
2. Contact resistance: $\leq 0.03\Omega$;
3. Insulation resistance: $\geq 100M\Omega$ (DC250V);
4. Withstand voltage: 500VAC;
5. Insertion and extraction force: 3-20N;
6. life test: 5,000 cycles;

CPJ3537455

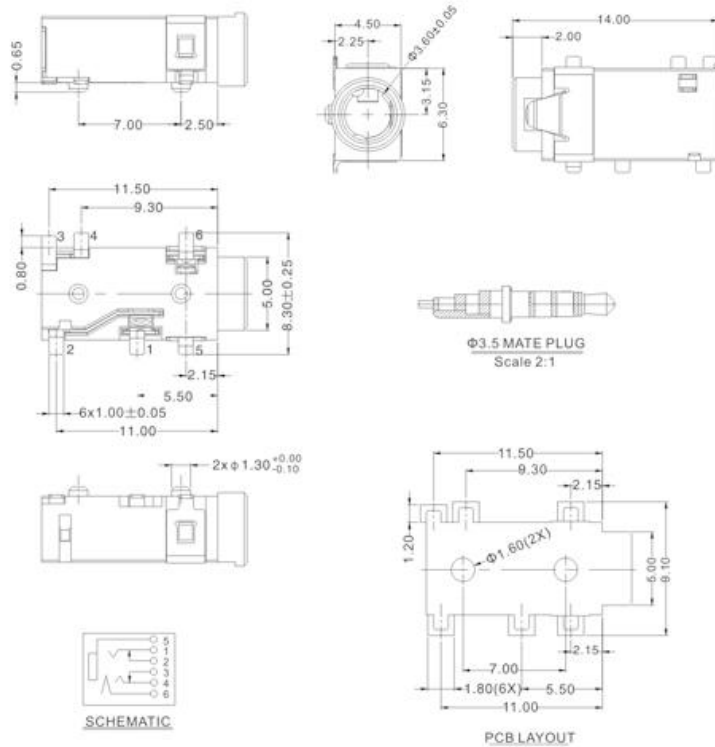

SPECIFICATION

1. CURRENT RATING: 0.3A, 16V DC.
2. CONTACT RESISTANCE: 30mΩ MAX.
3. INSULATION RESISTANCE: 100mΩ MIN AT 500V DC.
4. WITHSTAND VOLTAGE: AC 500V/1 MINUTE.
5. OPERATING TEMPERATURE RANGE: -25°C TO +85°C.
6. INSERTION FORCE: 0.4~3.0Kgf.
7. EXTRACTION FORCE: 0.4~3.0Kgf.
8. MARKED "▼" ARE IMPORTANT DIMENSIONS.

CPJ393

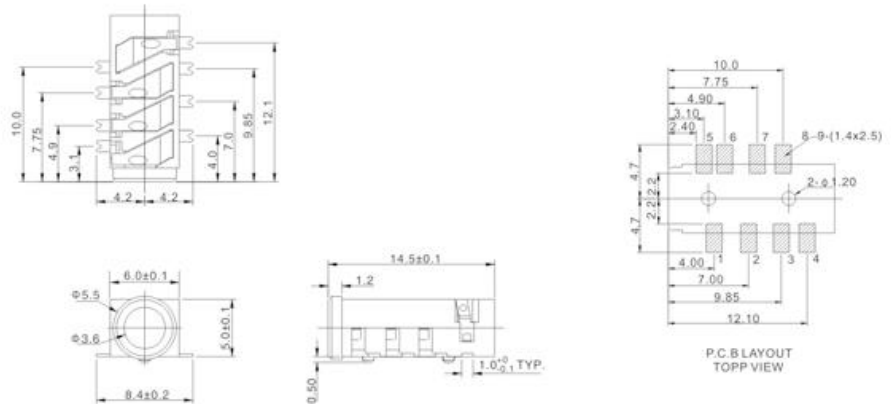

SCHEMATIC

CPJ-393	CPJ-393-1	CPJ-393-2	CPJ-393-3	CPJ-393-4	CPJ-393-5
CPJ-393-6	CPJ-393-7	CPJ-393-8	CPJ-393-9	CPJ-393-10	CPJ-393-11
CPJ-393-12	CPJ-393-13	CPJ-393-14			

SPECIFICATION

1. Rating: DC 30V 0.5A;
2. Contact resistance: ≤0.03Ω;
3. Insulation resistance: ≥100MΩ (DC250V);
4. Withstand voltage: 500VAC;
5. Insertion and extraction force: 3-20N;
6. life test: 5,000 cycles;

CPJ327A

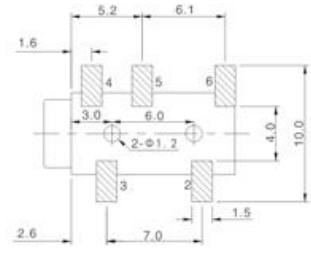
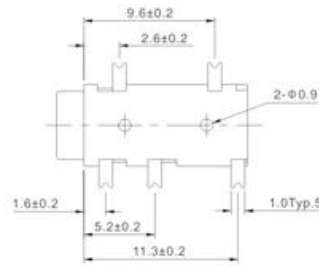
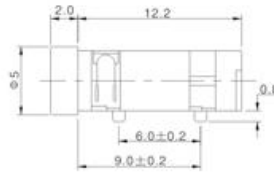
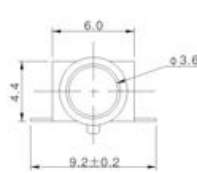

P.C.B. LAYOUT TOP VIEW

SPECIFICATION

1. Rating: DC 30V 0.5A;
2. Contact resistance: $\leq 0.03 \Omega$;
3. Insulation resistance: $\geq 100M \Omega$ (DC250V);
4. Withstand voltage: 500VAC;
5. Insertion and extraction force: 3-20N;
6. life test: 5,000 cycles;

SCHEMATIC

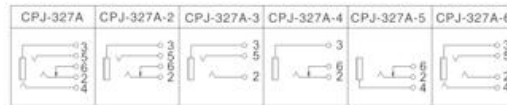

CPJ3005A

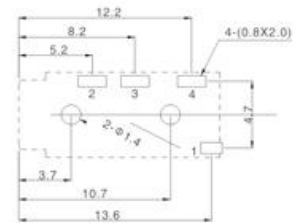

P.C.B. LAYOUT TOP VIEW

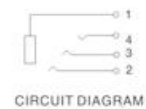
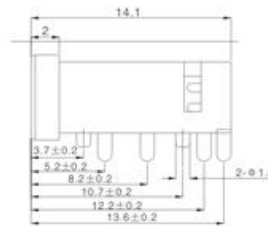
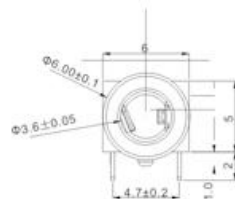

SPECIFICATION

1. Rating: DC 30V 0.5A;
2. Contact resistance: $\leq 0.03 \Omega$;
3. Insulation resistance: $\geq 100M \Omega$ (DC250V);
4. Withstand voltage: 500VAC;
5. Insertion and extraction force: 3-20N;
6. life test: 5,000 cycles;

CPJ300806

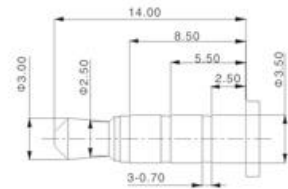
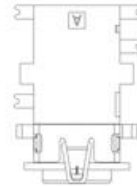
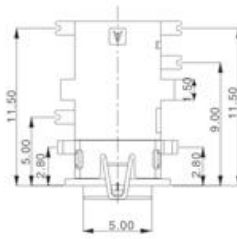

($\phi 3.50$ mm 4POLE PLUG DETAIL DRAWING)

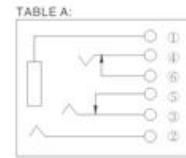
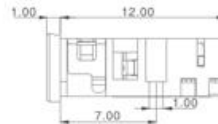
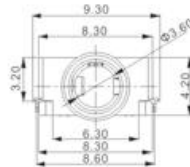

SCHEMATIC

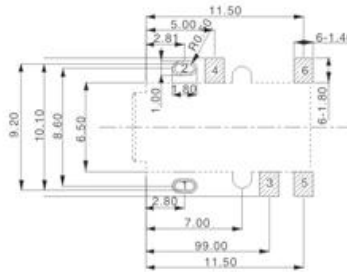

P.C.B LAYOUT TOP VIEW

NOTES:

1. CONTACT CURRENT RATING: 1A.
2. CONTACT RESISTANCE: 50m Ω MAX.;
3. INSULATION RESISTANCE: 1000m Ω MIN.;
4. DIELECTRIC WITHSTANDING: 500V AC MIN.;
5. DURABILITY: 5,000 CYCLES MIN.;
6. CONNECTOR MATING FORCES: 29.4N(3.00Kgf) MAX.;
7. CONNECTOR UNMATING FORCES: 2.94N(0.30Kgf) MIN.;
8. PRODUCT MEET THE REQUEST OF THE RoHs, SEE TABLE A;

CPJ3550

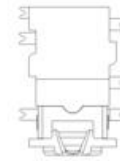
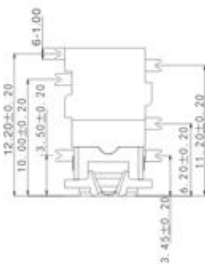

PCB LAYOUT TOP VIEW

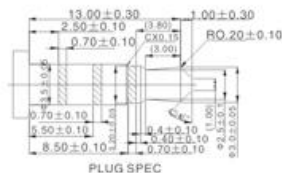
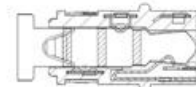
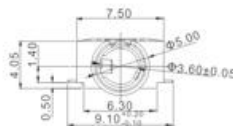

PLUG SPEC

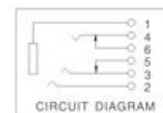

CIRCUIT DIAGRAM

NOTES:

1. CONTACT CURRENT RATING: 1A.
2. CONTACT RESISTANCE: 50m Ω MAX.;
3. INSULATION RESISTANCE: 1000m Ω MIN.;
4. DIELECTRIC WITHSTANDING: 500V AC MIN.;
5. DURABILITY: 5,000 CYCLES MIN.;
6. CONNECTOR MATING FORCES: 29.4N(3.00Kgf) MAX.;
7. CONNECTOR UNMATING FORCES: 2.94N(0.30Kgf) MIN.;
8. PRODUCT MEET THE REQUEST OF THE RoHs, SEE TABLE A;

CPJ3191

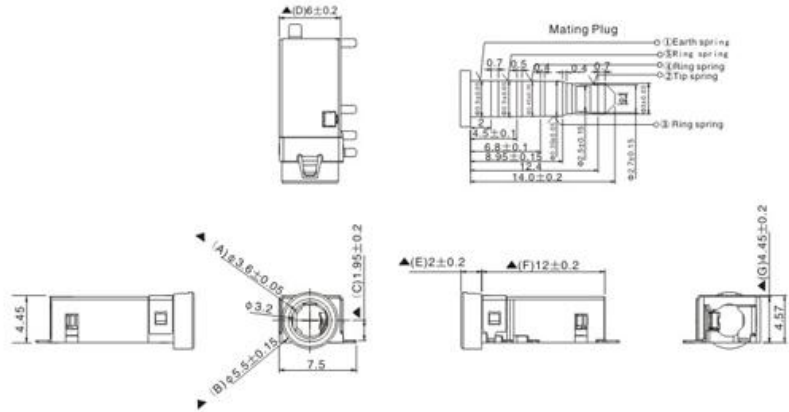

SPECIFICATION

- Rating: DC 30V 0.5A;
- Contact resistance: $\leq 0.03 \Omega$;
After test: $\leq 50m\Omega$
- Insulation resistance: $\geq 100M\Omega$ (500VDC);
After test: $\geq 50m\Omega$
- Withstand voltage: 500VAC;
- Insertion and extraction force: 3N~30N;
- life test: 5,000 cycles min;
- Operation temperature range: -20°C~70°C
- Preservative temperature range: -40°C~85°C
- Sign*▲"is importance dimension

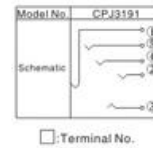
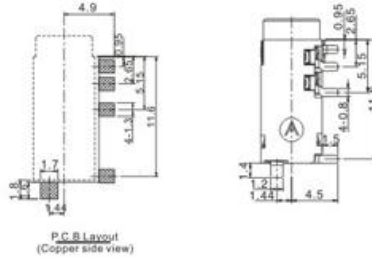

CPJ3096

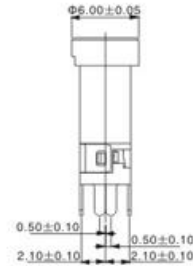
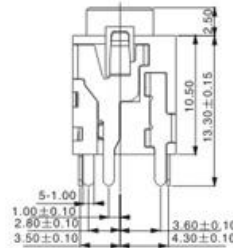
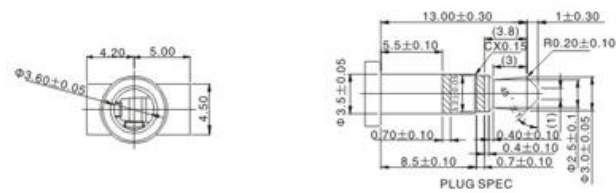

SPECIFICATION

- Rating: DC 30V 0.5A;
- Contact resistance: $\leq 0.03 \Omega$;
After test: $\leq 50m\Omega$
- Insulation resistance: $\geq 100M\Omega$ (500VDC);
After test: $\geq 50m\Omega$
- Withstand voltage: 500VAC;
- Insertion and extraction force: 3N~30N;
- life test: 5,000 cycles min;
- Operation temperature range: -20°C~70°C
- Preservative temperature range: -40°C~85°C
- Sign*▲"is importance dimension

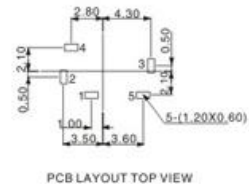
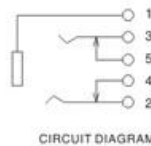

CPJ3113

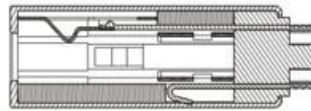

MATING PLUG

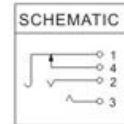
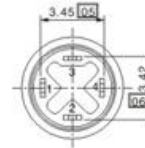
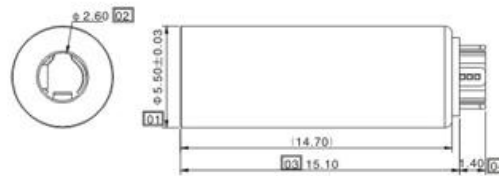
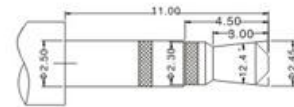

SPECIFICATION

1. Rating: DC 30V 0.5A;
2. Contact resistance: $\leq 0.03\Omega$;
3. Insulation resistance: $\geq 100M\Omega$ (DC250V);
4. Withstand voltage: 500VAC;
5. Insertion and extraction force: 3-20N;
6. life test: 5,000 cycles.

CPJ3566

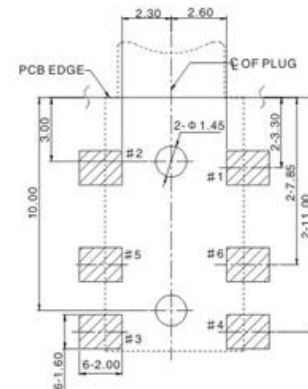
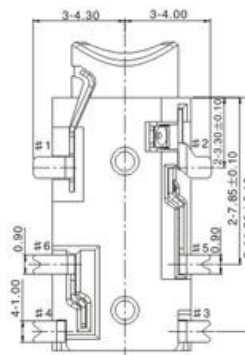
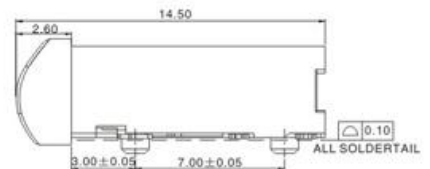
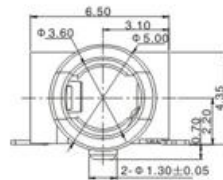

RECOMMENDED PCB LAYOUT TOP VIEW (TOLERANCE: ± 0.05)

SPECIFICATIONS:

1. ELECTRICAL CHARACTERISTICS:
 - 1-1. RATING: DC 12V 0.5A
 - 1-2. CONTACT RESISTANCE: 30m Ω MAX.(INITIAL)
 - 1-3. DIELECTRIC WITHSTANDING VOLTAGE: 500V AC FOR ONE MINUTE
 - 1-4. INSULATION RESISTANCE: 100m Ω MIN. MEASURED BY 500V DC
2. MECHANICAL CHARACTERISTICS:
 - 2-1. INSERTION FORCE : 0.3~3.0 KGF
 - 2-2. WITHDRAWAL FORCE: 0.3~3.0KGF
3. LIFE TEST: 10,000 CYCLES MIN.
4. FOR REFLOW SOLDERING LEAD-FREE PROCESS.
5. * REPRESENT CRITICAL DIMENSIONS.

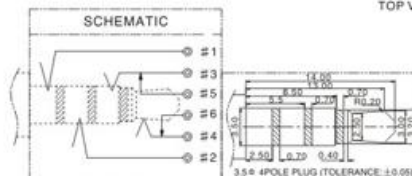

CPJ300601



NOTES:

- 1.0. RATING:
 - 1.1. VOLTAGE: 12 VAC (R.M.S.)
 - 1.2. CURRENT: 1 AMPERE MAXIMUM PER CONTACT AT 30°C T-RISE
 - 1.3. TEMPERATURE: -20°C TO +70°C
- 2.0. ELECTRICAL CHARACTERISTIC:
 - 2.1. CONTACT RESISTANCE: 50 MILLIOHMS MAXIMUM INITIAL
 - 2.2. INSULATION RESISTANCE: 100 MEGOHMS MINIMUM
 - 2.3. DIELECTRIC WITHSTANDING VOLTAGE: 500 VAC AT SEA LEVEL
- 3.0. MATERIALS:
 - 3.1. CONTACT: COPPER ALLOY
 - 3.2. HOUSING: THERMOPLASTIC, GLASS FILLED. 130°C/UL94V-0 RATED
- 4.0. MECHANICAL:
 - 4.1. INSERTION FORCE (PER CONTACT): 300 - 3000 GRAMS
 - 4.2. WITHDRAWAL FORCE (PER CONTACT): 300 - 3000 GRAMS
 - 4.3. DURABILITY, MINIMUM: MATED 5000 TIMES WITHOUT DEGRADING ELECTRICAL CHARACTERISTICS
 - 4.4. CONTACT FORCE, MINIMUM: 80 GRAMS

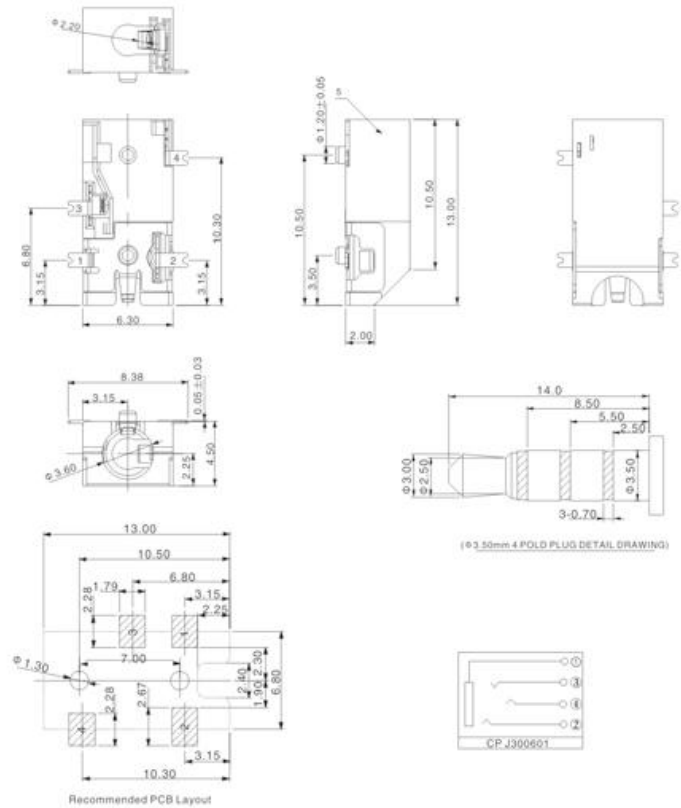

CPJ301201

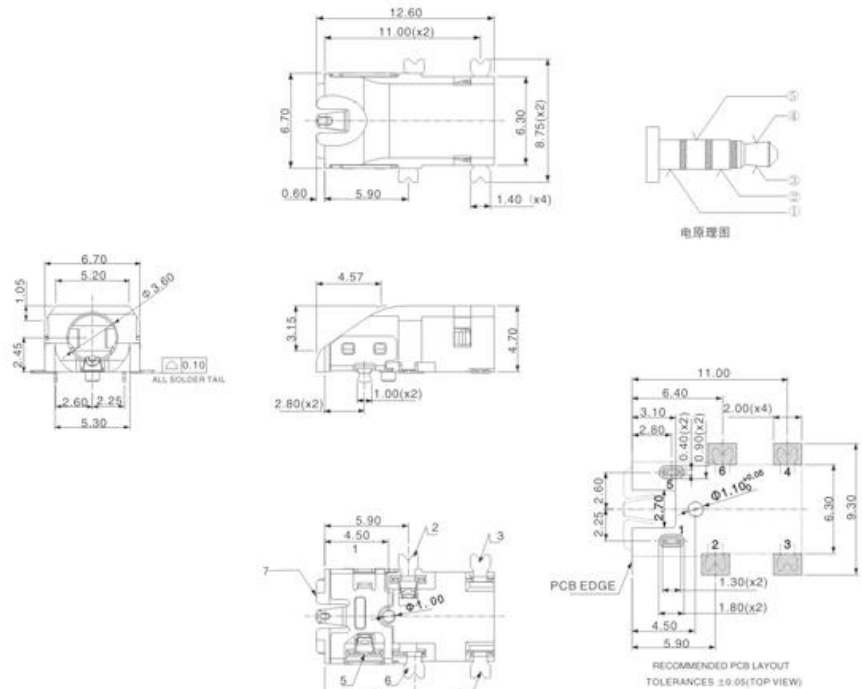

NOTES:

1. CONTACT CURRENT RATING: 1A.
2. CONTACT RESISTANCE: 50mΩ MAX.;
3. INSULATION RESISTANCE: 1000mΩ MIN.;
4. DIELECTRIC WITHSTANDING: 500V AC MIN.;
5. DURABILITY: 5,000 CYCLES MIN.;
6. CONNECTOR MATING FORCES: 29.4N(3.00Kg) MAX.;
7. CONNECTOR UNMATING FORCES: 2.94N(0.30Kg) MIN.;
8. PRODUCT MEET THE REQUEST OF THE RoHs, SEE TABLE A;

CPJ302302

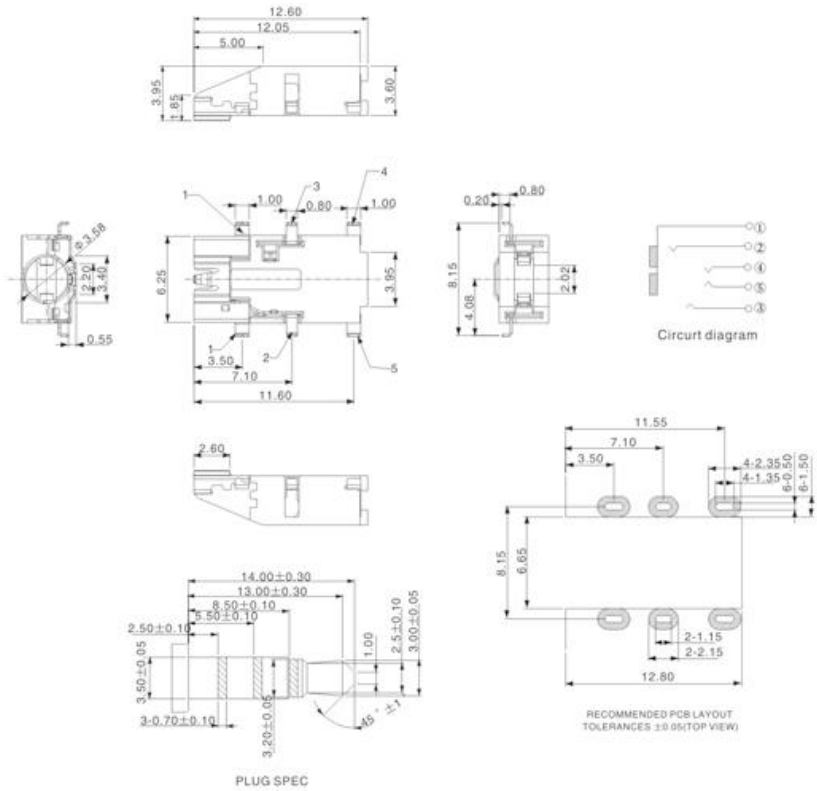

NOTES:

- CONTACT CURRENT RATING: 1A.
- CONTACT RESISTANCE: 50mΩ MAX.;
- INSULATION RESISTANCE: 1000mΩ MIN.;
- DIELECTRIC WITHSTANDING: 500V AC MIN.;
- DURABILITY: 5,000 CYCLES MIN.;
- CONNECTOR MATING FORCES: 29.4N(3.00KgF) MAX.;
- CONNECTOR UNMATING FORCES: 2.94N(0.30KgF) MIN.;

CPJ303201

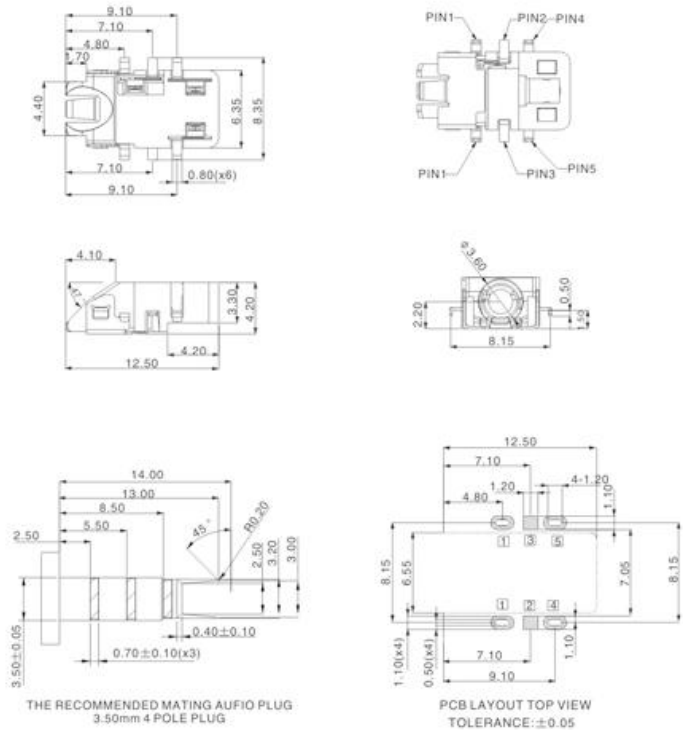

NOTES:

- RATING:
 - VOLTAGE: 12 VDC(R.M.S.)
 - CURRENT: 1 AMPERE MAXIMUM PER CONTACT AT 30°C T-RISE
 - TEMPERATURE: -25°C TO +85°C?
- ELECTRICAL CHARACTERISTIC
 - CONTACT RESISTANCE: INITIAL 50mΩ MAX. AFTER 100m
 - INSULATION RESISTANCE: 100MΩ MIN.
 - DIELECTRIC WITHSTANDING COLTAGE: 500 VAC AT SEA LEVEL
- MECHANICAL:
 - DURABILITY, MINIMUM: MATED 5000 CYCLES WITHOUT DEGRADING ELECTRICAL
 - INITIAL: MATING FORCE: 300g 2000g. UNMATING FORCE: 300g 2000g
 - AFTER LIFE TESTING: MATING FORCE: 300g 2000g. UNMATING FORCE: 300g 2000g

CPJ3200

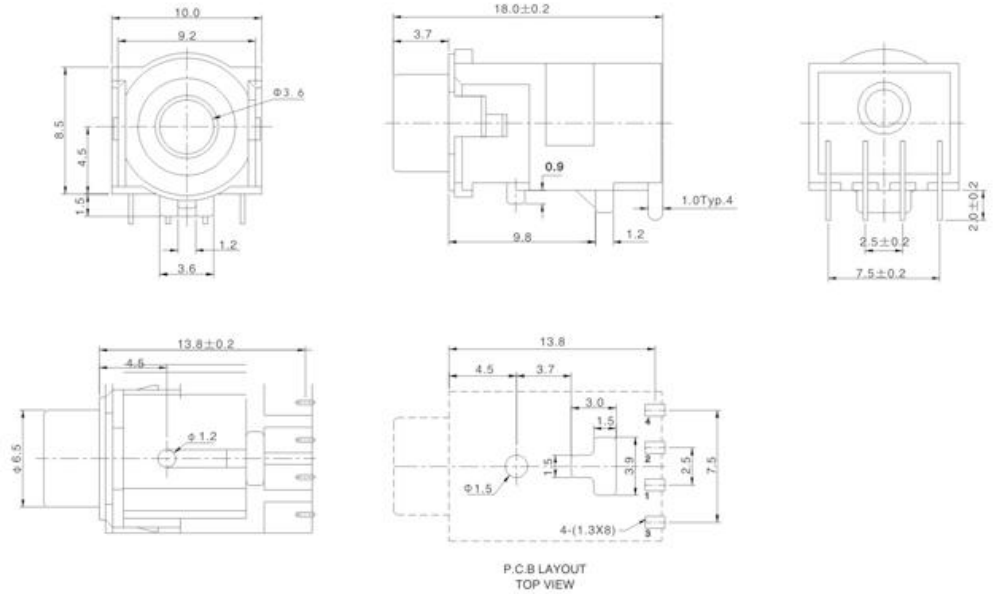

SPECIFICATION

1. Rating: DC 30V 1.0A;
2. Contact resistance: $\leq 0.03 \Omega$;
3. Insulation resistance: $\geq 100M \Omega$ (DC250V);
4. Withstand voltage: 500VAC;
5. Insertion and extraction force: 3-20N;
6. life test: 5,000 cycles;

SCHEMATIC



CPJ3204

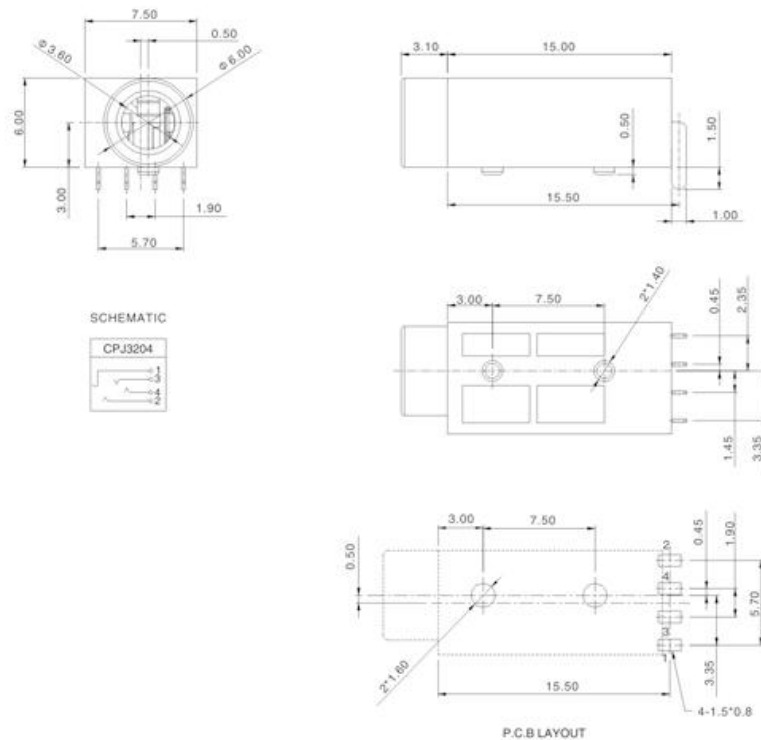

SPECIFICATION

1. Rating: DC 30V 0.5A;
2. Contact resistance: $\leq 0.03 \Omega$;
3. Insulation resistance: $\geq 100M \Omega$ (DC250V);
4. Withstand voltage: 500VAC;
5. Insertion and extraction force: 3-20N;
6. life test: 5,000 cycles;

SCHEMATIC



CDC002

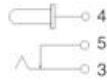
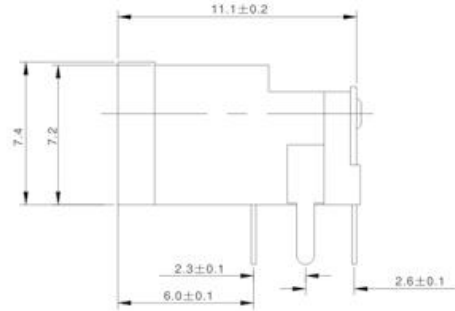
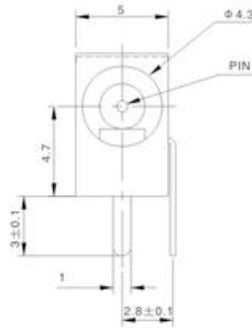

SCHEMATIC

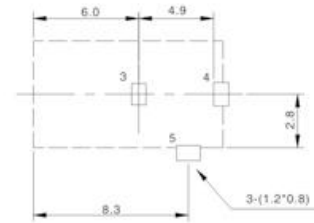

P.C.B LAYOUT TOP VIEW

PIN	φ0.7	φ1.0	φ1.3	φ1.65
APPD				

SPECIFICATION

1. Rating: DC 30V 0.5A;
2. Contact resistance: $\leq 0.03\Omega$;
3. Insulation resistance: $\geq 100M\Omega$ (DC250V);
4. Withstand voltage: 500VAC;
5. Insertion and extraction force: 3-20N;
6. life test: 5,000 cycles;

CDC005

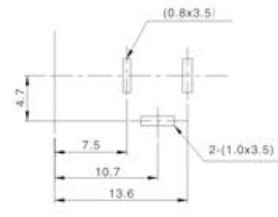
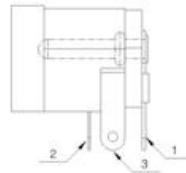
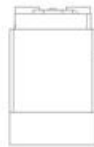

PCB LAYOUT TOP VIEW

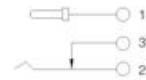
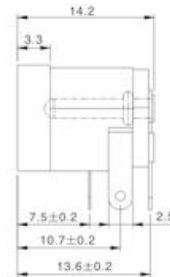
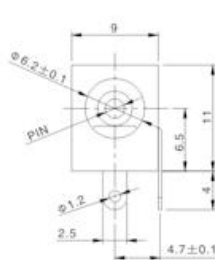

CIRCUIT DIAGRAM

PIN	φ1.65	φ2.0	φ2.35	φ2.5
APPD				

SPECIFICATION

1. Rating: DC 30V 0.5A;
2. Contact resistance: $\leq 0.03\Omega$;
3. Insulation resistance: $\geq 100M\Omega$ (DC250V);
4. Withstand voltage: 500VAC;
5. Insertion and extraction force: 3-20N;
6. life test: 5,000 cycles;

CDC031A

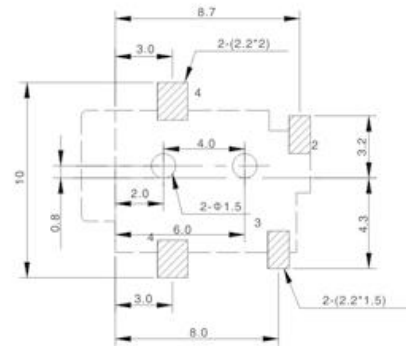
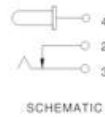
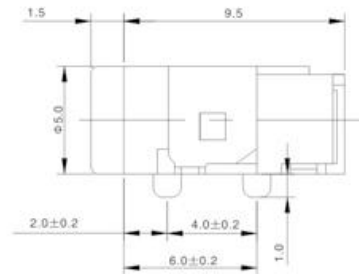
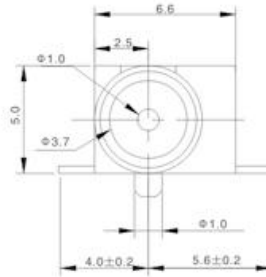

P.C.B LAYOUT
TOP VIEW

SPECIFICATION

1. Rating: DC 30V 0.5A;
2. Contact resistance: $\leq 0.03 \Omega$;
3. Insulation resistance: $\geq 100M \Omega$ (DC250V);
4. Withstand voltage: 500VAC;
5. Insertion and extraction force: 3-20N;
6. life test: 5,000 cycles;

CDC045B

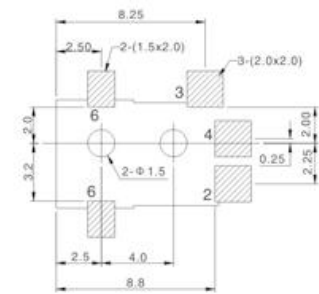
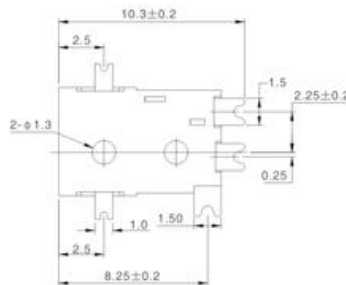
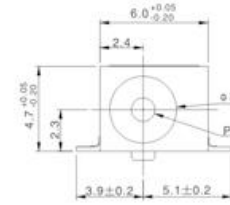
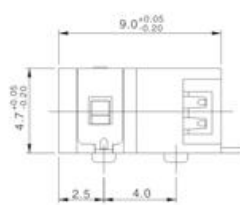

P.C.B LAYOUT
TOP VIEW



PIN	φ1.0	φ1.3
APPD		

SPECIFICATION

1. Rating: DC 30V 0.5A;
2. Contact resistance: $\leq 0.03 \Omega$;
3. Insulation resistance: $\geq 100M \Omega$ (DC250V);
4. Withstand voltage: 500VAC;
5. Insertion and extraction force: 2-20N;
6. life test: 5,000 cycles;

CDC055

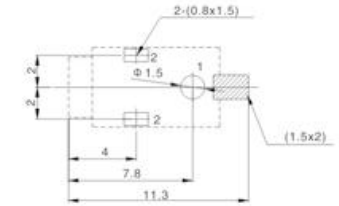
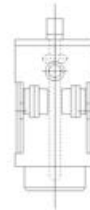
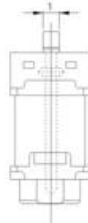

PCB LAYOUT TOP VIEW

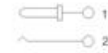
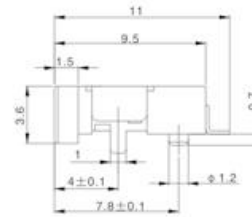
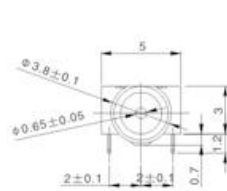

CIRCUIT DIAGRAM

SPECIFICATION

1. Rating: DC 30V 0.5A;
2. Contact resistance: $\leq 0.03 \Omega$;
3. Insulation resistance: $\geq 100M \Omega$ (DC250V);
4. Withstand voltage: 500VAC;
5. Insertion and extraction force: 3-20N;
6. life test: 5,000 cycles;

CDC085

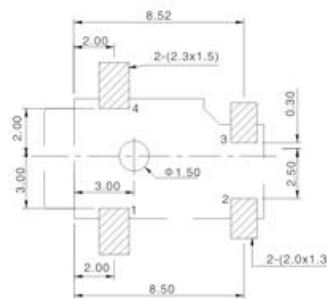
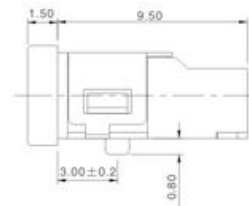
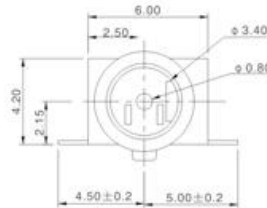

P.C.B LAYOUT TOP VIEW



SCHEMATIC

SPECIFICATION

1. Rating: DC 30V 0.5A;
2. Contact resistance: $\leq 0.03 \Omega$;
3. Insulation resistance: $\geq 100M \Omega$ (DC250V);
4. Withstand voltage: 500VAC;
5. Insertion and extraction force: 3-20N;
6. life test: 5,000 cycles;

CDC0507

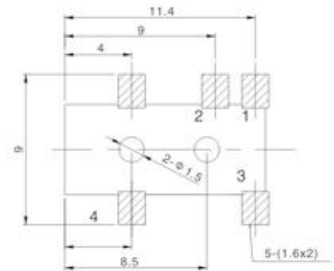
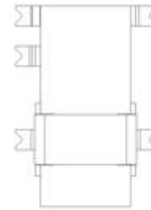
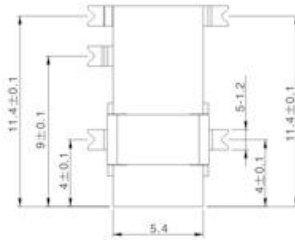

PCB LAYOUT TOP VIEW

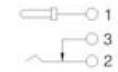
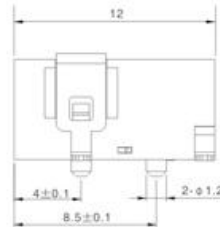
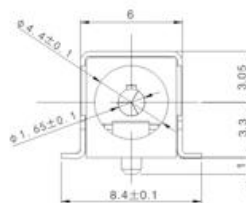

CIRCUIT DIAGRAM

SPECIFICATION

1. Rating: DC 50V 0.5A;
2. Contact resistance: $\leq 0.03 \Omega$;
3. Insulation resistance: $\geq 100M \Omega$ (DC250V);
4. Withstand voltage: 500VAC;
5. Insertion and extraction force: 3-15N;
6. life test: 5,000 cycles;

CDC0509

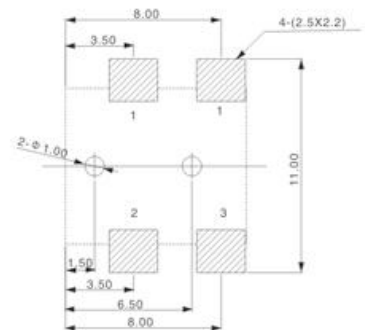
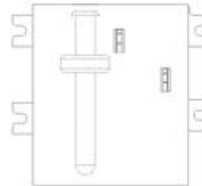
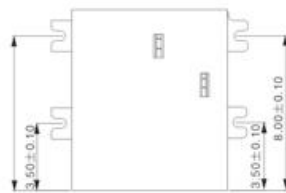

PCB LAYOUT TOP VIEW

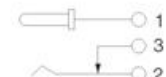
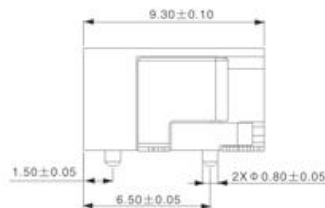
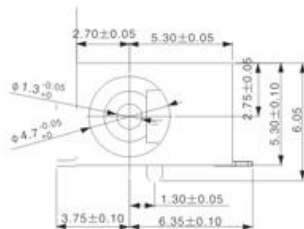

CIRCUIT DIAGRAM

SPECIFICATION

1. Rating: DC 16V 3.5A;
2. Contact resistance: $\leq 0.03 \Omega$;
3. Insulation resistance: $\geq 100M \Omega$ (DC250V);
4. Withstand voltage: 500VAC;
5. Insertion and extraction force: 3-20N;
6. life test: 5,000 cycles;

CDC0511

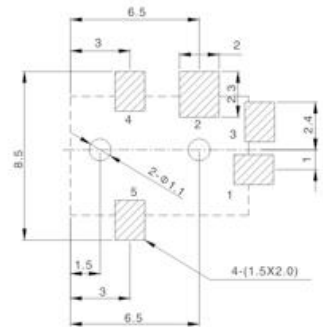
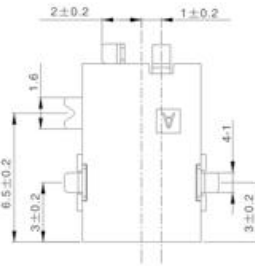

PCB LAYOUT TOP VIEW

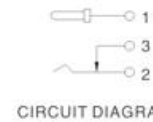
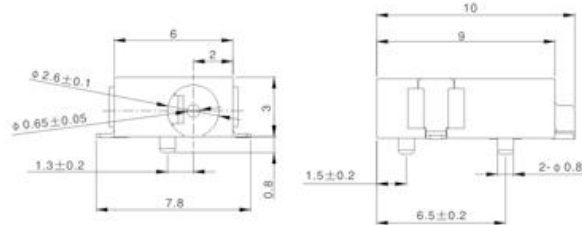

CIRCUIT DIAGRAM

SPECIFICATION

1. Rating: DC 50V 0.5A;
2. Contact resistance: $\leq 0.03 \Omega$;
3. Insulation resistance: $\geq 100M \Omega$ (DC250V);
4. Withstand voltage: 500VAC;
5. Insertion and extraction force: 3-15N;
6. life test: 5,000 cycles;

CDC0521

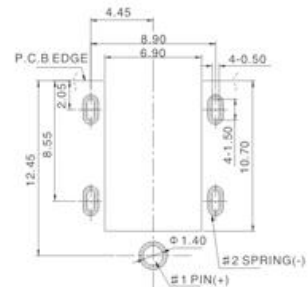
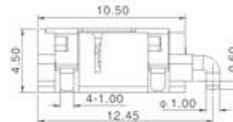
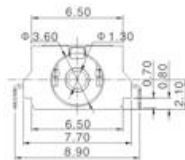

RECOMMENDED PCB LAYOUT TOP VIEW (TOLERANCE ± 0.05)

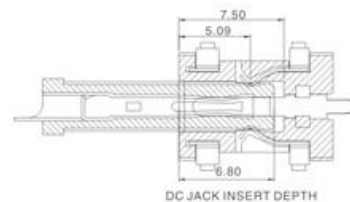
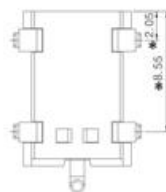

ELECTRICAL CIRCUIT

SPECIFICATIONS:

1. ELECTRICAL CHARACTERISTICS:

- 1-1. RATING:
- 1-2. CONTACT RESISTANCE: 30m Ω MAX.(INITIAL)
- 1-3. DIELECTRIC WITHSTANDING VOLTAGE: 500V AC FOR ONE MINUTE
- 1-4. INSULATION RESISTANCE: 100m Ω MIN. MEASURED BY 500V DC

2. MECHANICAL CHARACTERISTICS:

- 2-1. INSERTION FORCE : 0.3-3.0 KGF
- 2-2. WITHDRAWAL FORCE: 0.3-3.0KGF

3. LIFE TEST: 5,000 CYCLES MIN.

4. FOR REFLOW SOLDERING LEAD-FREE PROCESS.

5. * REPRESENT CRITICAL DIMENSIONS.

6. ∇ CPK CONTROLLED DIMENSIONS.

CDC044A

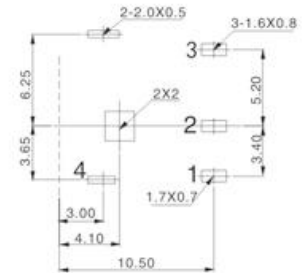
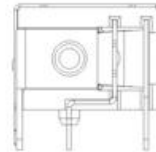
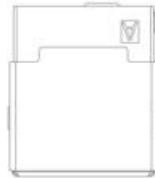

PCB LAYOUT TOP VIEW

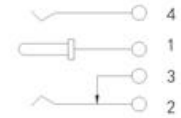
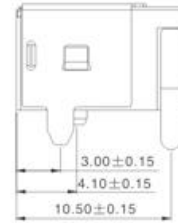
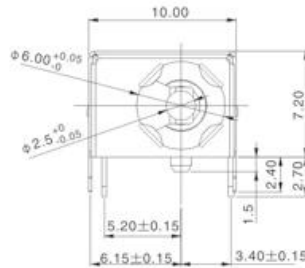

CIRCUIT DIAGRAM

SPECIFICATION

1. Rating: DC 30V 2.0A;
2. Contact resistance: $\leq 0.03 \Omega$;
3. Insulation resistance: $\geq 100M \Omega$ (DC250V);
4. Withstand voltage: 500VAC;
5. Insertion and extraction force: 5-40N;
6. Life test: 5,000 cycles;

CDC0037

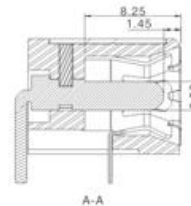

A-A

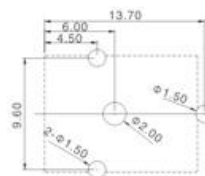
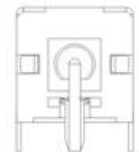
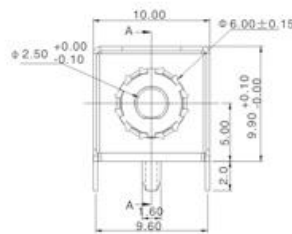

P.C.B LAYOUT

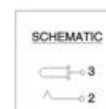

SCHEMATIC

SPECIFICATION

1. Rating: DC 30V 7A;
2. Contact resistance: $\leq 0.03 \Omega$;
3. Insulation resistance: $\geq 100M \Omega$ (DC250V);
4. Withstand voltage: 500VAC;
5. Insertion and extraction force: 5-40N;
6. Life test: 5,000 cycles;

CDC0015S

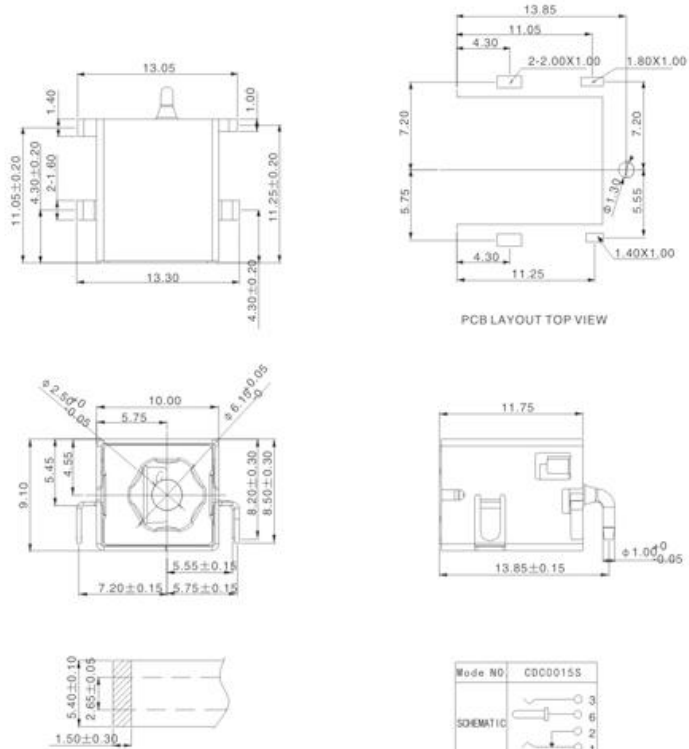

SPECIFICATION

1. Rating: DC 24V 3A;
2. Contact resistance: $\leq 0.03 \Omega$;
3. Insulation resistance: $\geq 100M \Omega$ (DC250V);
4. Withstand voltage: 500VAC;
5. Insertion and extraction force: 5-40N;
6. life test: 5,000 cycles;

CDC0032H

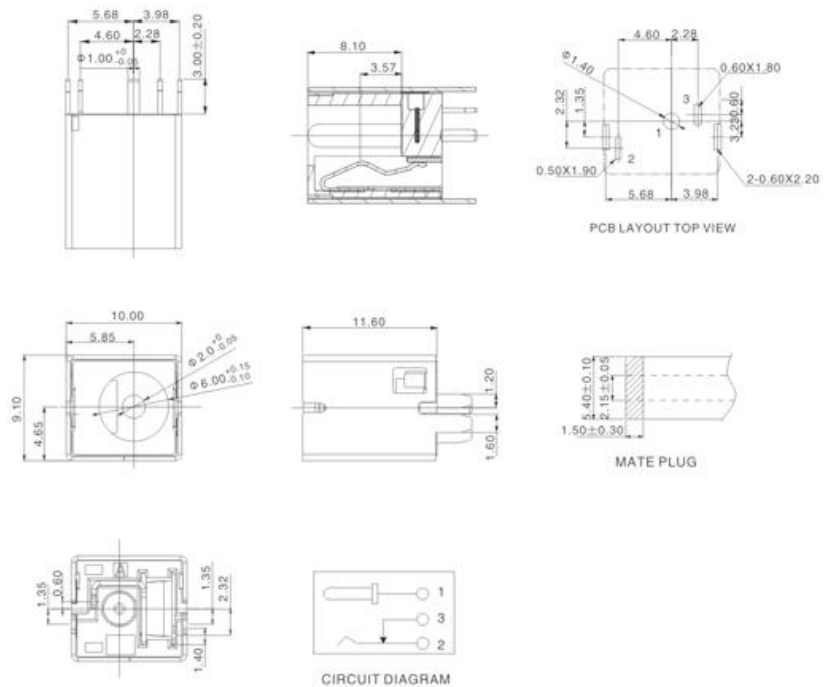

SPECIFICATION

1. Rating: DC 24V 3A;
2. Contact resistance: $\leq 0.03 \Omega$;
3. Insulation resistance: $\geq 100M \Omega$ (DC250V);
4. Withstand voltage: 500VAC;
5. Insertion and extraction force: 5-40N;
6. life test: 5,000 cycles;

BATTERY 3P 2.2MM H=2.1MM

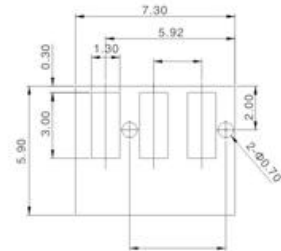
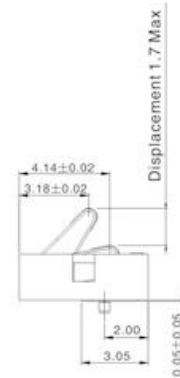
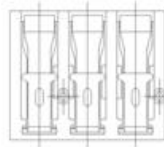
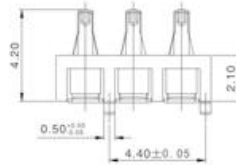
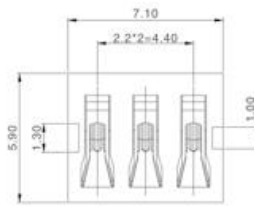

RECOMMENDED PC BOARD LAYOUT
TOLERANCE: ±0.05[TOP VIEW]

NOTES

1. MATERIAL & FLASH/PLATED
 - 1.1 HOUSING: HIGH TEMP.THERMOPLASTIC+GLASS FIBRE [UL 94V-0]; COLOR:BLACK
 - 1.2 TERMINAL: COPPER ALLOY
PLATED:GOLD FLASH ON CONTACT AREA.
GOLD FLASH ALL OVER
BASE NICKEL:50u "
 - 1.3 COVER: HIGH TEMP. THERMOPLASTIC+GLASS FIBRE [UL94V-0]; COLOR:BLACK
- 2.PACKAGE: TAPE/REEL

BATTERY 4P 2.2MM H=2.1MM

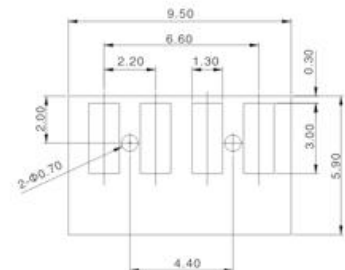
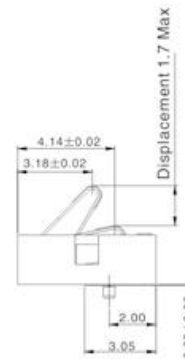
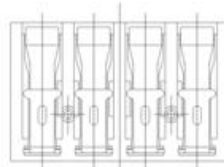
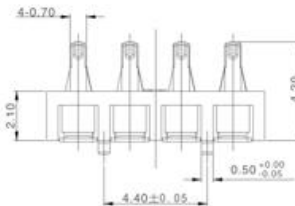
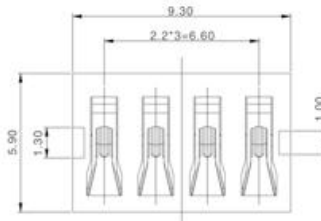

RECOMMENDED PC BOARD LAYOUT
TOLERANCE: ±0.05[TOP VIEW]

NOTES

1. MATERIAL & FLASH/PLATED
 - 1.1 HOUSING: HIGH TEMP.THERMOPLASTIC+GLASS FIBRE [UL 94V-0]; COLOR:BLACK
 - 1.2 TERMINAL: COPPER ALLOY
PLATED:GOLD FLASH ON CONTACT AREA.
GOLD FLASH ALL OVER
BASE NICKEL:50u "
 - 1.3 COVER: HIGH TEMP. THERMOPLASTIC+GLASS FIBRE [UL94V-0]; COLOR:BLACK
- 2.PACKAGE: TAPE/REEL

BATTERY 3P 3.0MM H=1.8MM

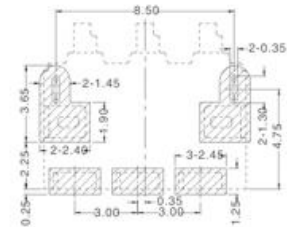
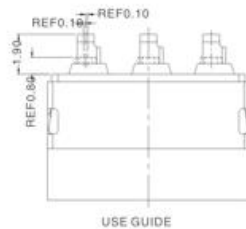
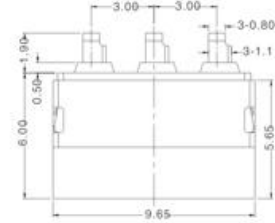
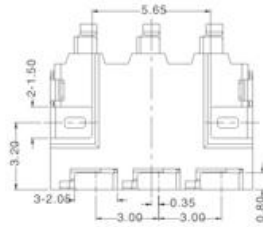

PCB LAYOUT

Notes:

1. Materials:
 - 1.1 Housing: High temperature thermoplastic UL94 V-0, BLACK.
 - 1.2 Contact: copper alloy.
 - 1.3 Shell: copper alloy.
2. Specifications:
 - 2.1. Current rating: 0.5 A Max.
 - 2.2. Dielectric withstanding: voltage: 500V(AC) for 1 min.
 - 2.3. Contact resistance: 60mΩ Max.
 - 2.4. Insulation resistance: 500MΩ Min.
 - 2.5. Temperature range: -30℃~+80℃

BATTERY 3P 3.0MM H=XMM

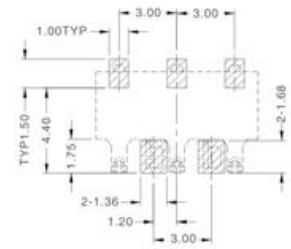
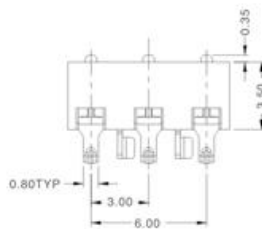

RECOMMEND PCB LAYOUT TOP VIEW
TOLERANCE: ±0.05
■ PCB AREA □ CONNECT AREA

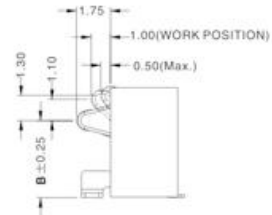
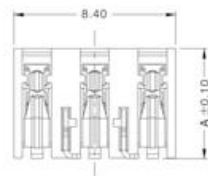

NOTES:

1. MATERIALS
 - 1.1. HOUSING: THERMOPLASTIC, UL94-V0.
 - 1.2. TERMINAL: COPPER ALLOY.
PLATING: NICKEL PLATED OVERALL, GOLD PLATED ON CONTACT AREA AND SOLDER TAILS.
 - 1.3. SOLDER: COPPER ALLOY
PLATING: Matte-tin
2. SPECIFICATIONS:
 - 2.1. CURRENT RATING: 0.5AMP MAX.
 - 2.2. DIELECTRIC WITHSTANDING VOLTAGE: 500V AC FOR 1 MINUTE.
 - 2.3. CONTACT RESISTANCE: 50m OHMS MAX.
 - 2.4. INSULATION RESISTANCE: 500M OHMS MIN AT 250V DC.
 - 2.5. DURABILITY(LIFE CYCLES): 3000 CYCLES.
 - 2.6. OPERATION TEMPERATURE: -25℃~+85℃.

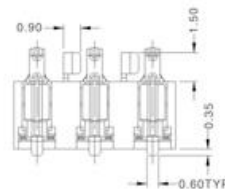
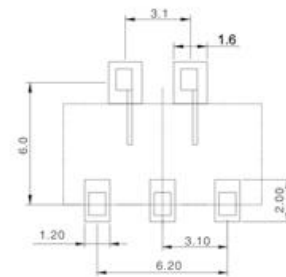
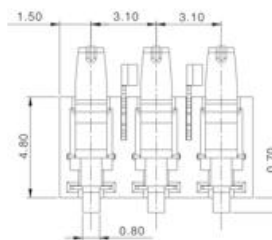
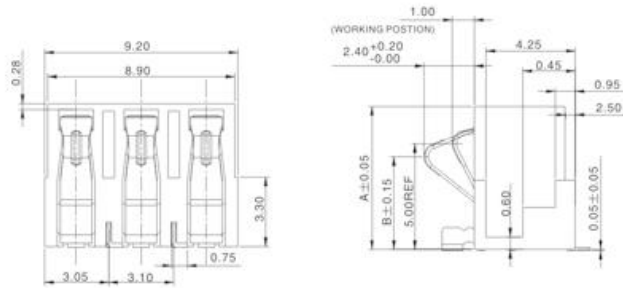

TABLE:

No.	PART No.	DIM A	DIM B
1	CBA03305401002	5.40	3.70
2	CBA03305701002	5.70	4.00
3	CBA03307501002	6.00	4.30
4	CBA03306201002	6.20	4.50
5	CBA03306501002	6.50	4.80

BATTERY 3P 3.1MM H=6.8-7.7MM



PCB LAYOUT

PART NO.	A	B
CBA3103884877	7.70	5.40
CBA3103884868	6.80	4.50

NOTES:

1. Material:

1.1. Insulator: High temperature thermoplastic UL94V-0, (BLACK LCP)

1.2. Beryllium copper: Plating, gold(3-8U") over nickel(50-80U")

1.3. Pho. Bronze: Plating, Tin(100-120U") over nickel(50-80U")

2. Electrical specifications:

Voltage rating: 12 VAC

Current rating: 2.0A

Dielectric strength: 250V AC for 1 minute

Insulation resistance: 500 M Ω

Contact resistance: 50 M Ω

Operation temperature: -40°C to +105°C

MAX. processing temp: 260°C for 30 seconds

3. Mechanical specifications:

3.1 Durability: 5000 cycles

BATTERY 3P 2.5MM H=7.5MM

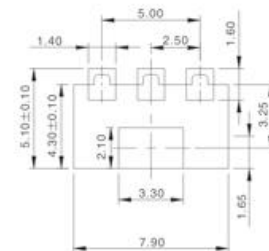
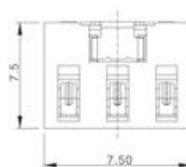
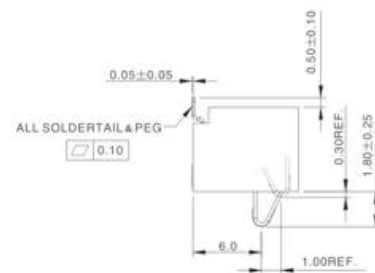
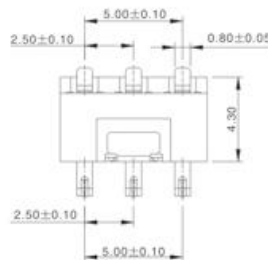

RECOMMENDED PCB LAYOUT
TOP VIEW (XX±0.05)

SPECIFICATIONS:

1. CURRENT RATING: 0.5A 50V AC/DC.

2. CONTACT RESISTANCE: 60mΩ MAX AT DC 20mA.

3. INSULATION RESISTANCE: 100MΩ MIN AT 500V DC.

4. OPERATING TEMPERATURE RANGE: -25°C TO +85°C.

BATTERY 3P 6.5MM H=8.6MM

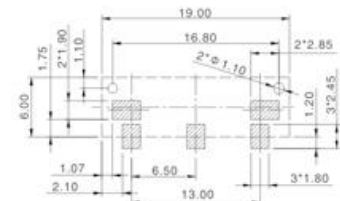
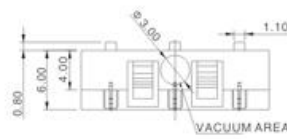

RECOMMEND P.C.B LAYOUT
TOLERANCE ± 0.05
TOP VIEW

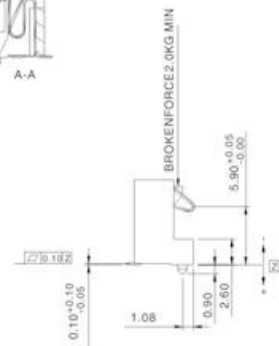
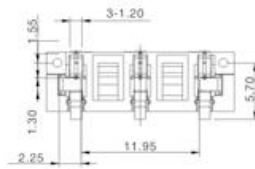
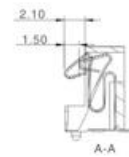
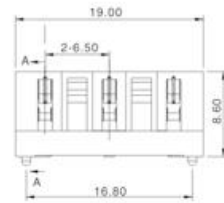

MATERIALS

1. HOUSING: HI-TEMP.
 2. TERMINAL: COPPER ALLOY (T=0.20mm). GOLD PLATED OVER NICKEL.
 3. SHELL: STAINLESS STEEL (T=0.20mm)
- SPECIFICATION**
1. CURRENT RATING: 1.5 A. MAX
 2. DIELECTRIC WITHSTANDING VOLTAGE: 500V AC R.M.S. FOR ONE MINUTE.
 3. INSULATION RESISTANCE: 500MΩ MIN. AT 250V DC.
 4. CONTACT RESISTANCE: 100mΩ MAX.
 5. OPERATING TEMPERATURE: -40 °C TO +105°C
 6. CONTACT FORCE: 160gf/min WHEN STROKE OF 1.5mm
 7. HOUSING BROKEN FORCE 2.0KG/min
- PACKAGE: TAPE/REEL

BATTERY 4P 2.0MM H=1.65MM

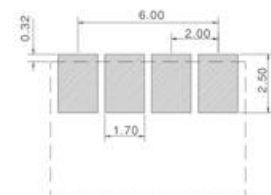
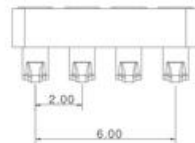
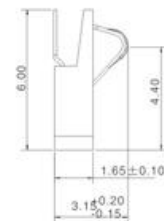
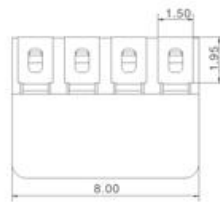

RECOMMENDED PCB LAYOUT
TOLERANCE ± 0.05

NOTES:

1. MATERIAL:
 - 1.1. HOUSING: Thermoplastic UL94v-0, BLACK
 - 1.2. CONTACT: COPPER ALLOY Au PLATED OVER NICKEL PLATED

BATTERY 4P 2.5MM H=1.9MM

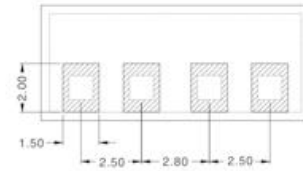
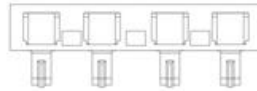

PCB LAYOUT

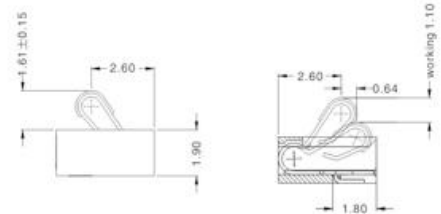
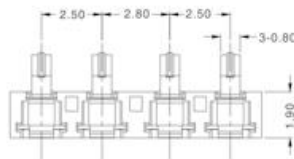
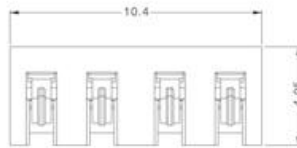

SPECIFICATIONS:

1. CURRENT RATING: 0.5A 50V AC/DC.
2. CONTACT RESISTANCE: 60mΩ MAX AT DC 20mA.
3. INSULATION RESISTANCE: 100MΩ MIN AT 500V DC.
4. OPERATING TEMPERATURE RANGE: -25°C TO +85°C.
5. MARKED "▼" ARE IMPORTANT DIMENSIONS.

BATTERY 3P 3.0MM H=2.1MM

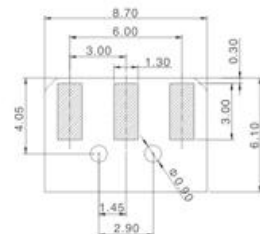
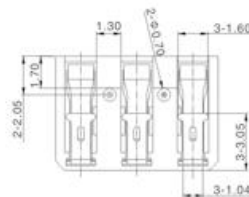
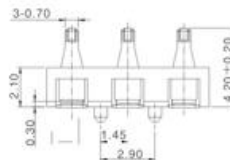
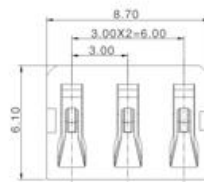

RECOMMENDED PC BOARD LAYOUT
TOLERANCE: ±0.05(TOP VIEW)

NOTES

1. MATERIAL & FLASH/PLATED
 - 1.1 HOUSING: HIGH TEMP. THERMOPLASTIC+GLASS FIBRE [UL 94V-0]; COLOR: BLACK
 - 1.2 TERMINAL: COPPER ALLOY
PLATED: 15u" GOLD ON CONTACT AREA, 1.5u" GOLD ON SOLDER AREA, GOLD FLASH ALL OVER
BASE NICKEL: 50-100u"
 - 1.3 COVER: HIGH TEMP. THERMOPLASTIC+GLASS FIBRE [UL94V-0]; COLOR: BLACK
2. PACKAGE: TAPE/REEL

BATTERY 4P 2.5MM H=3.5MM SINKING-BOARD TYPE

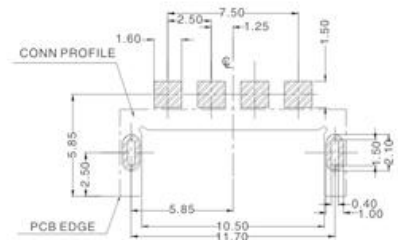
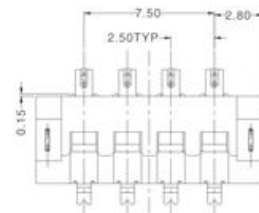
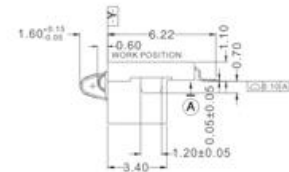
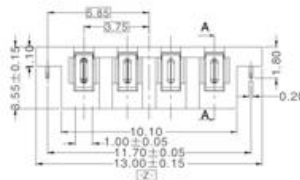
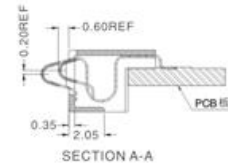
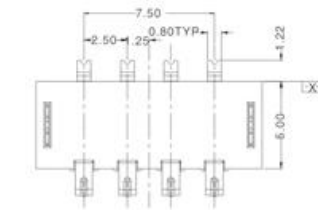

RECOMMENDED PCB LAYOUT
TOLERANCE IS ±0.05

NOTES:

1. MATERIAL:

- 1-1. HOUSING: THERMOPLASTIC RATING UL94V-0
- 1-2. CONTACT: COPPER ALLOY
- 1-3. PAD: COPPER ALLOY

2. FINISH:

- 2-1. CONTACT: 5U*MIN GOLD PLATED ON CONTACT AREA, GOLD FLASH PLATED ON SOLDER TAIL AREA
- 2-2. PAD: 80U*MIN, MATTE TIN PLATING OVER ALL

3. PRODUCT SPECIFICATIONS:

- 3-1. CURRENT RATING: 1.0A/DC MAX.
- 3-2. VOLTAGE RATING: 100V/DC MAX.
- 3-3. CONTACT RESISTANCE: 50m Ω ILLIONHM MAX.
- 3-4. DIELECTRIC WITHSTANDING VOLTAGE: 500V AC
- 3-5. INSULATION RESISTANCE: 500 M Ω EGOHMS MIN

4. PRODUCT COMPLIANCE WITH ROHS DIRECTIVE

BATTERY 4P 2.5MM H=6.5MM

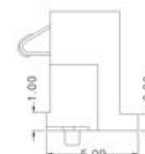
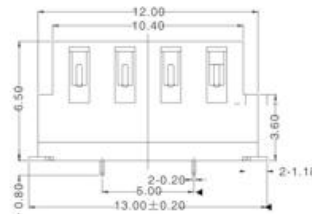
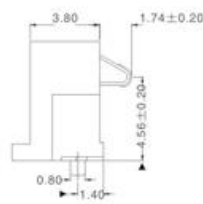
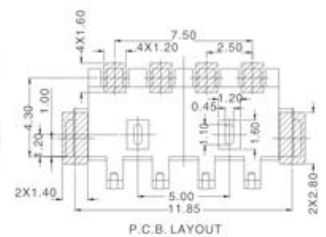
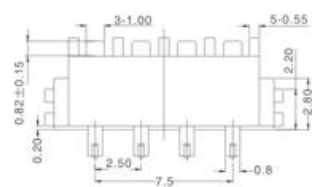
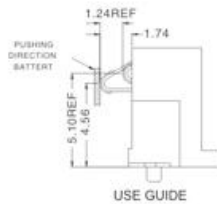

SPECIFICATION:

- 1. CURRENT RATING: 0.5A 50V AC/DC.
- 2. CONTACT RESISTANCE: 60m MAX AT DC 20mA.
- 3. INSULATION RESISTANCE: 100M Ω MIN AT 500V DC.
- 4. OPERATING TEMPERATURE RANGE: -25 °C TO +85 °C.

WAFER 0.8MM XP SIDE ENTRY TYPE

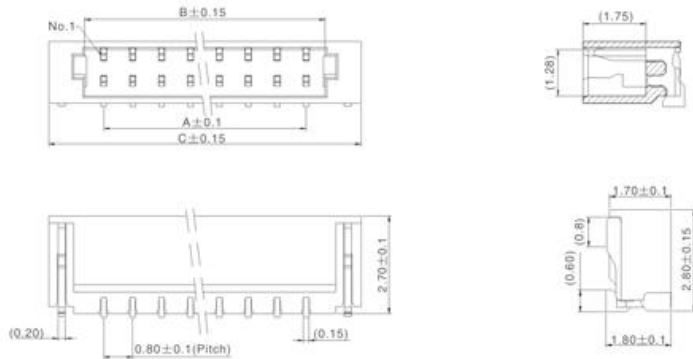

PIN	A	B	C
2	0.8	1.85	3.85
3	1.6	2.65	4.65
4	2.4	3.45	5.45
5	3.2	4.25	6.25
6	4	5.05	7.05
7	4.8	5.85	7.85
8	5.6	6.65	8.65
9	6.4	7.45	9.45
10	7.2	8.25	10.25
11	8	9.05	11.05
12	8.8	9.85	11.85
13	9.6	10.65	12.65
14	10.4	11.45	13.45
15	11.2	12.25	14.25
16	12	13.05	15.05
17	12.8	13.85	15.85
18	13.6	14.65	16.65
19	14.4	15.45	17.45
20	15.2	16.25	18.25
21	16	17.05	19.05
22	16.8	17.85	19.85
23	17.6	18.65	20.65
24	18.4	19.45	21.45

SPECIFICATION

1. Material:

Housing: HIGH-TEMP Plastic, UL94V-0, color: Natural.
 Contacts: Copper alloy.
 Solder tab: Copper alloy.

2. Electrical Characteristics:

Current rating: 0.5A(max).
 Voltage rating: 50V(max).
 Operating Temperature: -25°C~+85°C.
 Insulation resistance: 100M ohms min. at 500V DC
 Dielectric withstanding voltage: 500AC/minute.
 Contact resistance: 30m ohms max.

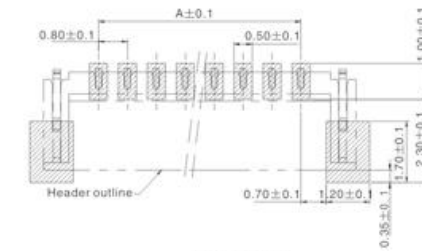

PCB Layout

WAFER 0.8MM XP VERTICAL ENTRY TYPE

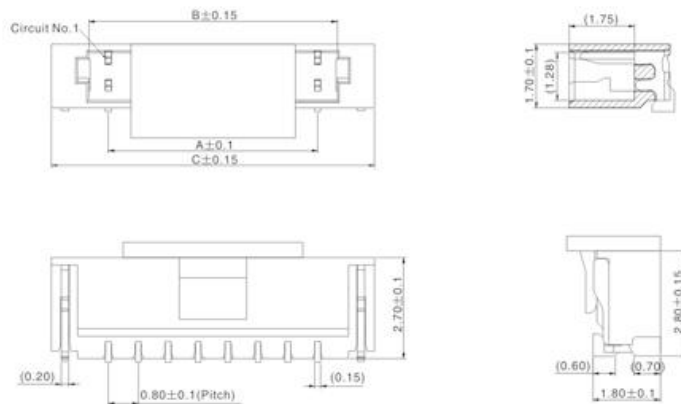

PIN	A	B	C
2	0.8	1.85	3.85
3	1.6	2.65	4.65
4	2.4	3.45	5.45
5	3.2	4.25	6.25
6	4	5.05	7.05
7	4.8	5.85	7.85
8	5.6	6.65	8.65
9	6.4	7.45	9.45
10	7.2	8.25	10.25
11	8	9.05	11.05
12	8.8	9.85	11.85
13	9.6	10.65	12.65
14	10.4	11.45	13.45
15	11.2	12.25	14.25
16	12	13.05	15.05
17	12.8	13.85	15.85
18	13.6	14.65	16.65
19	14.4	15.45	17.45
20	15.2	16.25	18.25
21	16	17.05	19.05
22	16.8	17.85	19.85

SPECIFICATION

1. Material:

Housing: HIGH-TEMP Plastic, UL94V-0, color: Natural.
 Contacts: Copper alloy.
 Solder tab: Copper alloy.

2. Electrical Characteristics:

Current rating: 0.5A(max).
 Voltage rating: 50V(max).
 Operating Temperature: -25°C~+85°C.
 Insulation resistance: 100M ohms min. at 500V DC
 Dielectric withstanding voltage: 500AC/minute.
 Contact resistance: 30m ohms max.

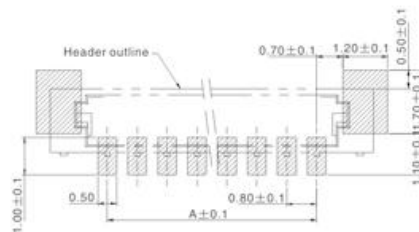

PCB Layout

WAFER 1.0MM XP SIDE ENTRY TYPE

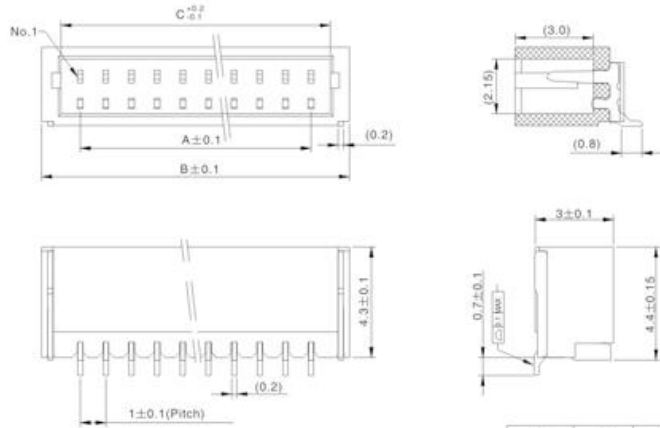

PIN	A	B	C
2	1	4	2.4
3	2	5	3.4
4	3	6	4.4
5	4	7	5.4
6	5	8	6.4
7	6	9	7.4
8	7	10	8.4
9	8	11	9.4
10	9	12	10.4
11	10	13	11.4
12	11	14	12.4
13	12	15	13.4
14	13	16	14.4
15	14	17	15.4
16	15	18	16.4
17	16	19	17.4
18	17	20	18.4
19	18	21	19.4
20	19	22	20.4

SPECIFICATION:

1. MATERIAL:

HOUSING: THERMOPLASTIC RATING UL94V-0, color: Natural.
 CONTACT: COPPER ALLOY.
 SOLDER: COPPER ALLOY

2. ELECTRICAL CHARACTERISTICS:

CURRENT RATING: 0.5A
 VOLTAGE RATING: 150V(max)
 OPERATION TEMPERATURE: -25°C~+85°C.
 INSULATION RESISTANCE: 1000 M OHMS MIN. AT 800V DC
 DIELECTRIC WITHSTANDING VOLTAGE: 800V AC/MINUTE.
 CONTACT RESISTANCE: 30M OHMS MAX.

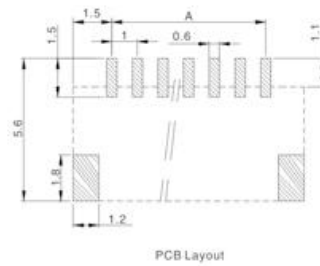

WAFER 1.0MM XP VERTICAL ENTRY TYPE

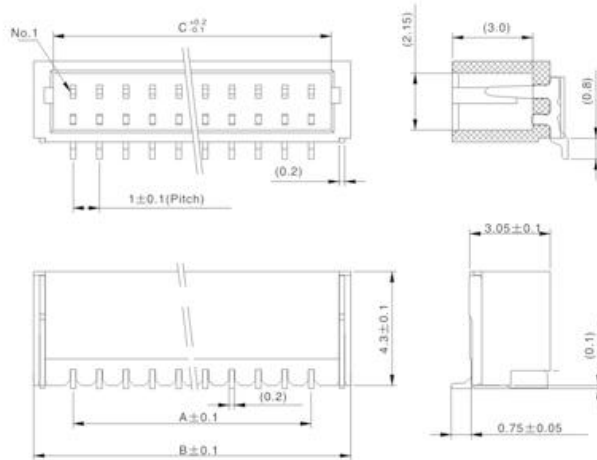

PIN	A	B	C
2	1	4	2.4
3	2	5	3.4
4	3	6	4.4
5	4	7	5.4
6	5	8	6.4
7	6	9	7.4
8	7	10	8.4
9	8	11	9.4
10	9	12	10.4
11	10	13	11.4
12	11	14	12.4
13	12	15	13.4
14	13	16	14.4
15	14	17	15.4
16	15	18	16.4
17	16	19	17.4
18	17	20	18.4
19	18	21	19.4
20	19	22	20.4

SPECIFICATION:

1. MATERIAL:

HOUSING: THERMOPLASTIC RATING UL94V-0, color: Natural.
 CONTACT: COPPER ALLOY.
 SOLDER: COPPER ALLOY

2. ELECTRICAL CHARACTERISTICS:

CURRENT RATING: 0.5A
 VOLTAGE RATING: 150V(max)
 OPERATION TEMPERATURE: -25°C~+85°C.
 INSULATION RESISTANCE: 1000 M OHMS MIN. AT 800V DC
 DIELECTRIC WITHSTANDING VOLTAGE: 800V AC/MINUTE.
 CONTACT RESISTANCE: 30M OHMS MAX.

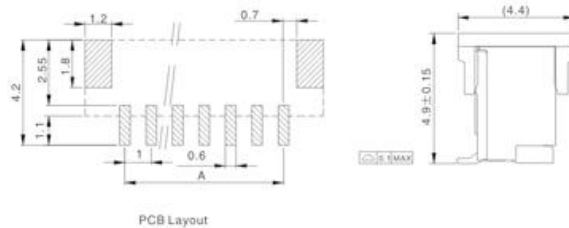

WAFER 1.0MM 2XP SIDE ENTRY TYPE

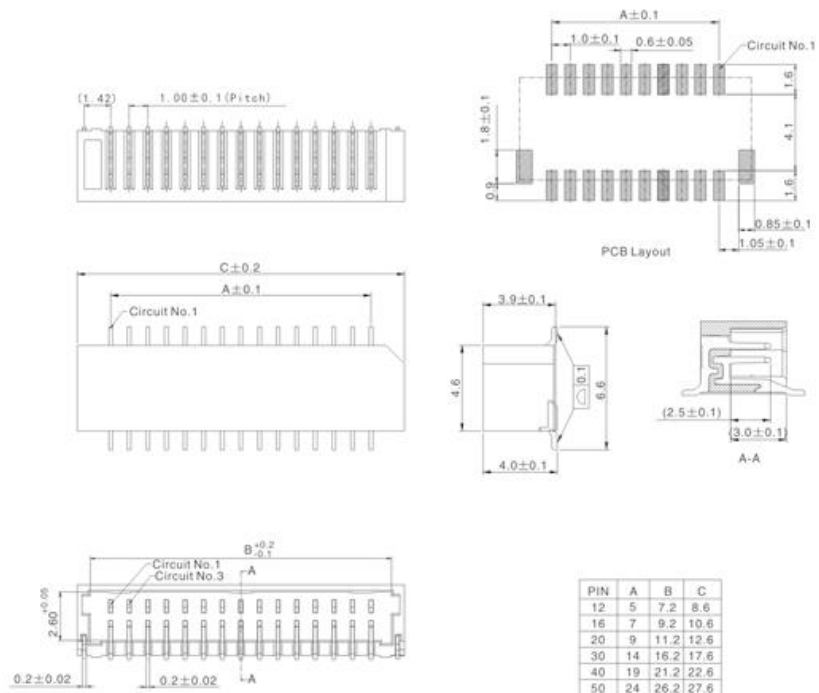

SPECIFICATION

- Material:
 - Housing: HIGH-TEMP Plastic, UL94V-0, color: Natural.
 - Contacts: Copper alloy.
 - Solder tab: Copper alloy.
- Electrical Characteristics:
 - Current rating: 0.5A(max).
 - Voltage rating: 50V(max).
 - Operating Temperature: $-25^{\circ}\text{C} \sim +85^{\circ}\text{C}$.
 - Insulation resistance: 100M ohms min. at 500V DC
 - Dielectric withstanding voltage: 500AC/minute.
 - Contact resistance: 30m ohms max.

WAFER 1.0MM 2XP VERTICAL ENTRY TYPE

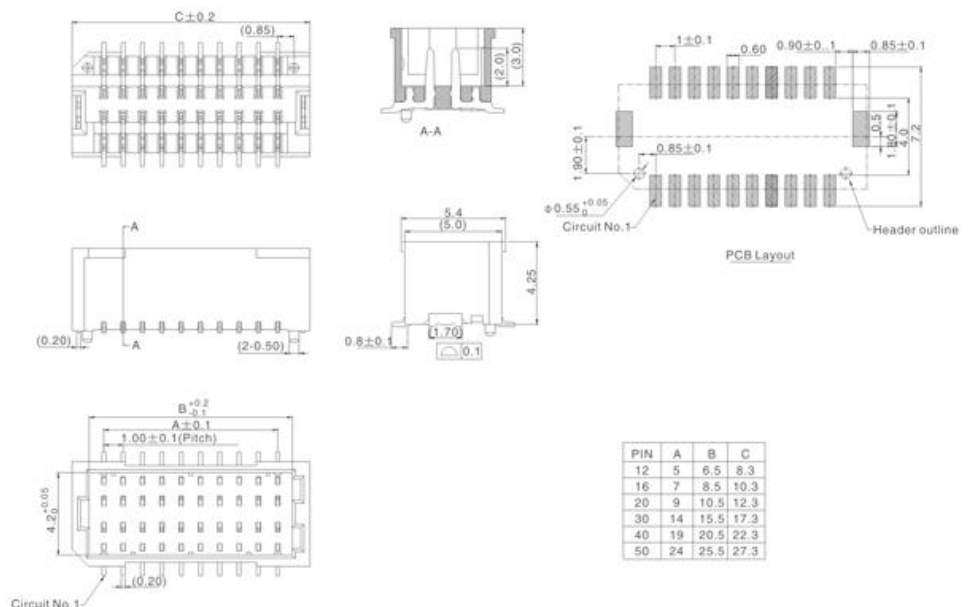

SPECIFICATION

- Material:
 - Housing: HIGH-TEMP Plastic, UL94V-0, color: Natural.
 - Contacts: Copper alloy.
 - Solder tab: Copper alloy.
- Electrical Characteristics:
 - Current rating: 0.5A(max).
 - Voltage rating: 50V(max).
 - Operating Temperature: $-25^{\circ}\text{C} \sim +85^{\circ}\text{C}$.
 - Insulation resistance: 100M ohms min. at 500V DC
 - Dielectric withstanding voltage: 500AC/minute.
 - Contact resistance: 30m ohms max.

WAFER 1.2MM XP H=1.4MM

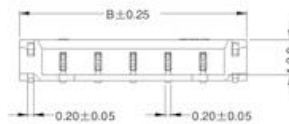
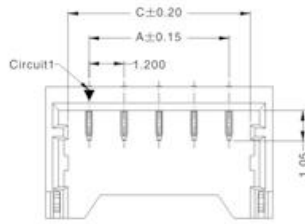

4P-5P Without Sticking Point
Scale 1:1

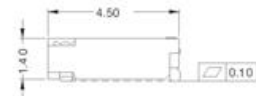

6P 7P With Sticking Point
Scale 1:1

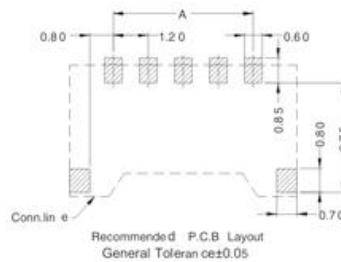

Poles	Dimensions(mm)		
	A	B	C
04	3.60	6.60	5.04
05	4.80	7.80	6.24
06	6.00	9.00	7.44
07	7.20	10.20	8.64

SPECIFICATIONS

Voltage rating: 50V AC/DC
 Current rating: 2.0A AC/DC
 Withstanding Voltage: 500V AC/minute
 Temperature range: -25°C~+85°C.
 Insulation resistance: ≥100MW
 Contact resistance: £20mW
 After environmental testing: £40mW

WAFER 1.25MM XP SMT SIDE ENTRY TYPE

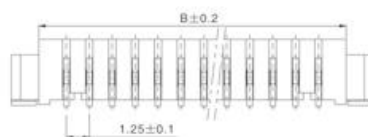
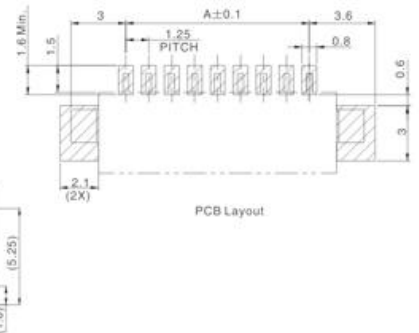
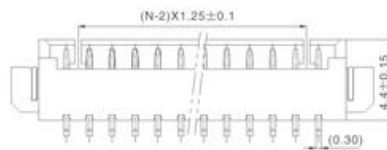
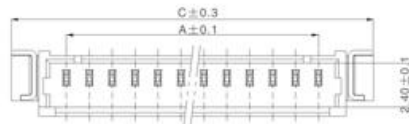

PIN	A	B	C
2	1.25	4.25	3.85
3	1.6	5.5	4.65
4	2.4	6.75	5.45
5	3.2	8.0	6.25
6	4	9.25	7.05
7	4.8	10.5	7.85
8	5.6	11.75	8.65
9	6.4	13.0	9.45
10	7.2	14.25	10.25
11	8	15.5	11.05
12	8.8	16.75	11.85
13	9.6	18.0	12.65
14	10.4	19.25	13.45
15	11.2	20.5	14.25
16	12	21.75	15.05

SPECIFICATION

1. Material:
 Housing: HIGH-TEMP Plastic, UL94V-0, color: Natural.
 Contacts: Copper alloy.
 Solder tab: Copper alloy.
 2. Electrical Characteristics:
 Current rating: 1A(max).
 Voltage rating: 200V(max).
 Operating Temperature: -25°C~+85°C.
 Insulation resistance: 1000M ohms min. at 1000V DC
 Dielectric withstanding voltage: 1000AC/minute.
 Contact resistance: 30m ohms max.

WAFER 1.25MM XP VERTICAL ENTRY TYPE

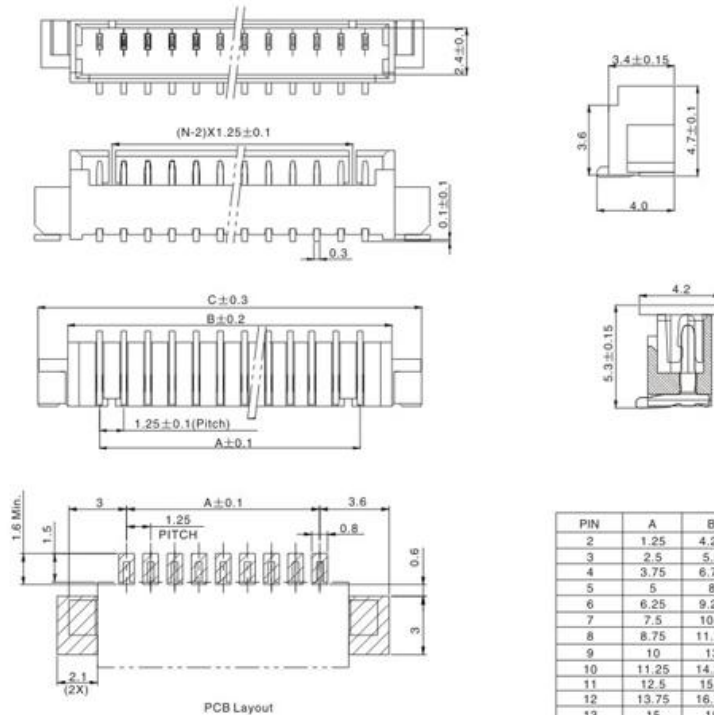

SPECIFICATION

- Material:
 - Housing: HIGH-TEMP Plastic, UL94V-0, color: Natural.
 - Contacts: Copper alloy.
 - Solder tab: Copper alloy.
- Electrical Characteristics:
 - Current rating: 1A(max).
 - Voltage rating: 200V(max).
 - Operating Temperature: -25°C~+85°C.
 - Insulation resistance: 1000M ohms min. at 1000V DC
 - Dielectric withstanding voltage: 1000AC/minute.
 - Contact resistance: 30m ohms max.

PIN	A	B	C
2	1.25	4.25	7.3
3	2.5	5.5	8.55
4	3.75	6.75	9.8
5	5	8	11.05
6	6.25	9.25	12.3
7	7.5	10.5	13.55
8	8.75	11.75	14.8
9	10	13	16.05
10	11.25	14.25	17.3
11	12.5	15.5	18.55
12	13.75	16.75	19.8
13	15	18	21.05
14	16.25	19.25	22.3
15	17.5	20.5	23.55
16	18.75	21.75	24.8

WAFER 1.25MM XP DIP90

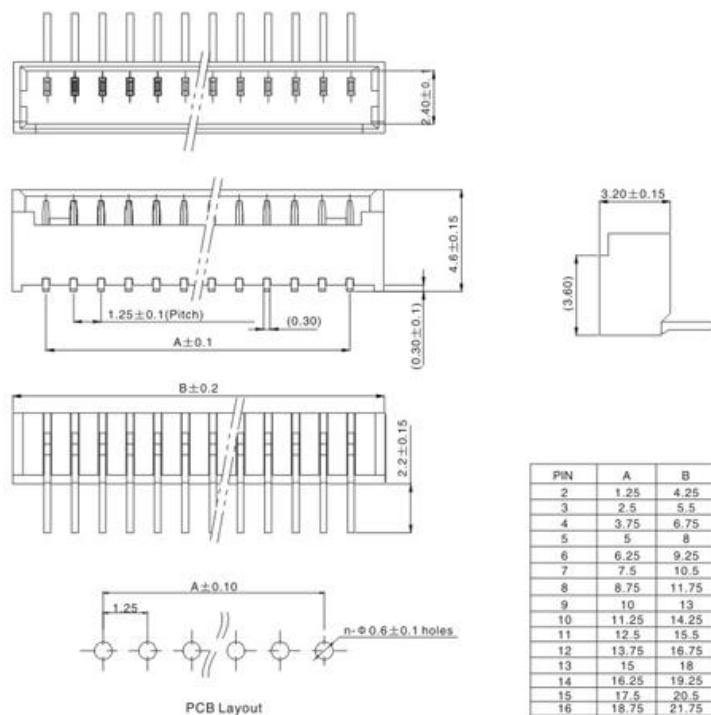

SPECIFICATION

- Material:
 - Housing: HIGH-TEMP Plastic, UL94V-0, color: Natural.
 - Contacts: Copper alloy.
 - Solder tab: Copper alloy.
- Electrical Characteristics:
 - Current rating: 1A(max).
 - Voltage rating: 200V(max).
 - Operating Temperature: -25°C~+85°C.
 - Insulation resistance: 1000M ohms min. at 1000V DC
 - Dielectric withstanding voltage: 1000AC/minute.
 - Contact resistance: 30m ohms max.

PIN	A	B
2	1.25	4.25
3	2.5	5.5
4	3.75	6.75
5	5	8
6	6.25	9.25
7	7.5	10.5
8	8.75	11.75
9	10	13
10	11.25	14.25
11	12.5	15.5
12	13.75	16.75
13	15	18
14	16.25	19.25
15	17.5	20.5
16	18.75	21.75

WAFER 1.25MM XP DIP180

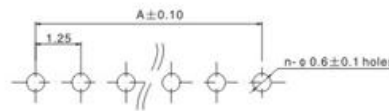
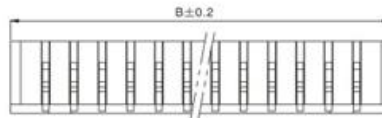
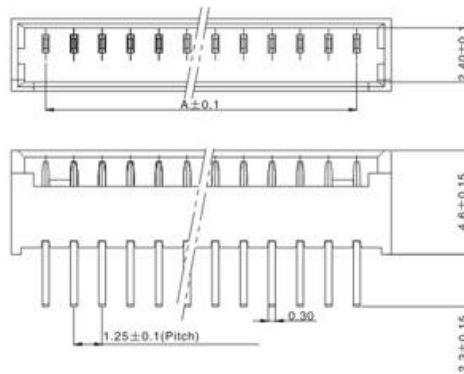

PCB Layout

PIN	A	B
2	1.25	4.25
3	2.5	5.5
4	3.75	6.75
5	5	8
6	6.25	9.25
7	7.5	10.5
8	8.75	11.75
9	10	13
10	11.25	14.25
11	12.5	15.5
12	13.75	16.75
13	15	18
14	16.25	19.25
15	17.5	20.5
16	18.75	21.75

SPECIFICATION

1. Material:

Housing: HIGH-TEMP Plastic, UL94V-0, color: Natural.

Contacts: Copper alloy.

Solder tab: Copper alloy.

2. Electrical Characteristics:

Current rating: 1A(max).

Voltage rating: 200V(max).

Operating Temperature: $-25^{\circ}\text{C} \sim +85^{\circ}\text{C}$.

Insulation resistance: 1000M ohms min. at 1000V DC

Dielectric withstanding voltage: 1000AC/minute.

Contact resistance: 30m ohms max.

WAFER 1.25MM XP SMT H=1.85MM

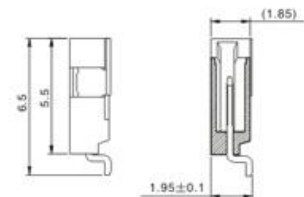
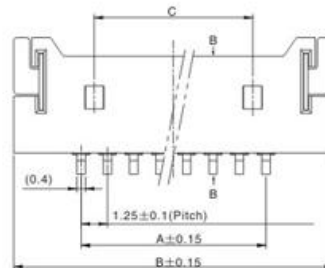

SECTION: B-B

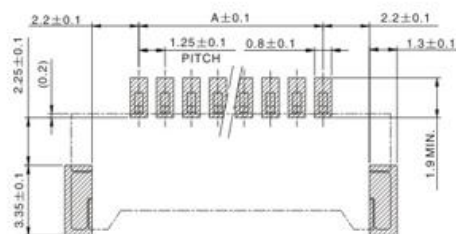

PCB Layout

PIN	A	B	C
2	1.25	7.65	
3	2.5	8.9	
4	3.75	10.15	2.5
5	5	11.4	3.75
6	6.25	12.65	5
7	7.5	13.9	6.25
8	8.75	15.15	7.5
9	10	16.4	8.75
10	11.25	17.65	10
11	12.5	18.9	11.25
12	13.75	20.15	12.5
13	15	21.4	13.75
14	16.25	22.65	15
15	17.5	23.9	16.25
16	18.75	25.15	17.5
17	20	26.4	18.75
18	21.25	27.65	20
19	22.5	28.9	21.25
20	23.75	30.15	22.5
21	25	31.4	23.75
22	26.25	32.65	25
23	27.5	33.9	26.25
24	28.75	35.15	27.5
25	30	36.4	28.75
26	31.25	37.65	30
27	32.5	38.9	31.25
28	33.75	40.15	32.5
29	35	41.4	33.75
30	36.25	42.65	35

SPECIFICATION

1. Material:

Housing: HIGH-TEMP Plastic, UL94V-0, color: Natural.

Contacts: Copper alloy.

Solder tab: Copper alloy.

2. Electrical Characteristics:

Current rating: 1A(max).

Voltage rating: 200V(max).

Operating Temperature: $-25^{\circ}\text{C} \sim +85^{\circ}\text{C}$.

Insulation resistance: 1000M ohms min. at 1000V DC

Dielectric withstanding voltage: 1000AC/minute.

Contact resistance: 30m ohms max.

WAFER 1.25MM XP SMT H=2.6MM

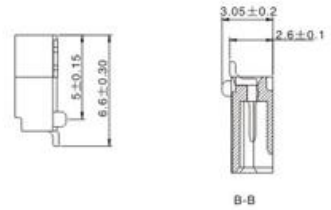
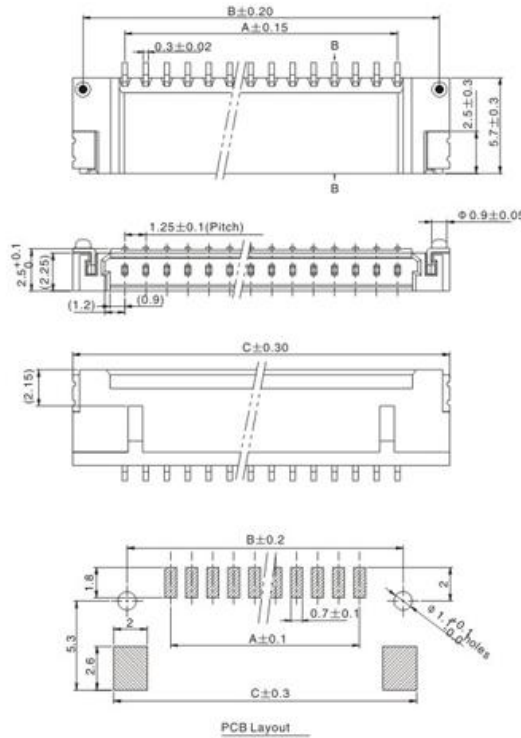

PIN	A	B	C
3	2.5	7.7	8.7
4	3.75	8.95	9.95
5	5	10.2	11.2
6	6.25	11.45	12.45
7	7.5	12.7	13.7
8	8.75	13.95	14.95
9	10	15.2	16.2
10	11.25	16.45	17.45
11	12.5	17.7	18.7
12	13.75	18.95	19.95
13	15	20.2	21.2
14	16.25	21.45	22.45
15	17.5	22.7	23.7
16	18.75	23.95	24.95
17	20	25.2	26.2
18	21.25	26.45	27.45
19	22.5	27.7	28.7
20	23.75	28.95	29.95
21	25	30.2	31.2
22	26.25	31.45	32.45
23	27.5	32.7	33.7
24	28.75	33.95	34.95
25	30	35.2	36.2
26	31.25	36.45	37.45
27	32.5	37.7	38.7
28	33.75	38.95	39.95
29	35	40.2	41.2
30	36.25	41.45	52.45

SPECIFICATION

- Material:
 - Housing: HIGH-TEMP Plastic, UL94V-0, color: Natural.
 - Contacts: Copper alloy.
 - Solder tab: Copper alloy.
- Electrical Characteristics:
 - Current rating: 1A(max).
 - Voltage rating: 200V(max).
 - Operating Temperature: -25°C~+85°C.
 - Insulation resistance: 1000M ohms min. at 1000V DC
 - Dielectric withstanding voltage: 1000AC/minute.
 - Contact resistance: 30m ohms max.

WAFER 1.25MM XP H=4.25MM SIDE ENTRY TYPE

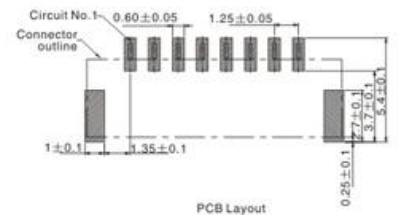
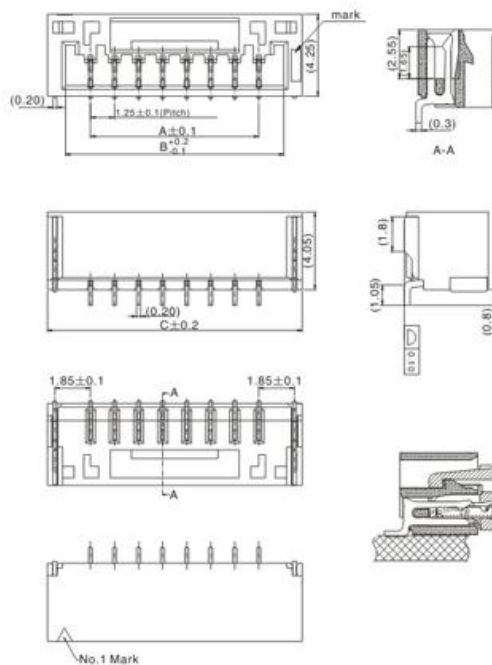

PIN	A	B	C
2	1.25	3.85	5.75
3	2.5	5.1	7
4	3.75	6.35	8.25
5	5	7.6	9.5
6	6.25	8.85	10.75
7	7.5	10.1	12
8	8.75	11.35	13.25
9	10	12.6	14.5
10	11.25	13.85	15.75
11	12.5	15.1	17
12	13.75	16.35	18.25
13	15	17.6	19.5
14	16.25	18.85	20.75
15	17.5	20.1	22
18	21.25	23.85	25.75
20	23.75	26.35	28.25

SPECIFICATION

- Material:
 - Housing: HIGH-TEMP Plastic, UL94V-0, color: Natural.
 - Contacts: Copper alloy.
 - Solder tab: Copper alloy.
- Electrical Characteristics:
 - Current rating: 1A(max).
 - Voltage rating: 200V(max).
 - Operating Temperature: -25°C~+85°C.
 - Insulation resistance: 1000M ohms min. at 1000V DC
 - Dielectric withstanding voltage: 1000AC/minute.
 - Contact resistance: 30m ohms max.

WAFER 1.25MM XP H=4.25MM VERTICAL ENTRY TYPE

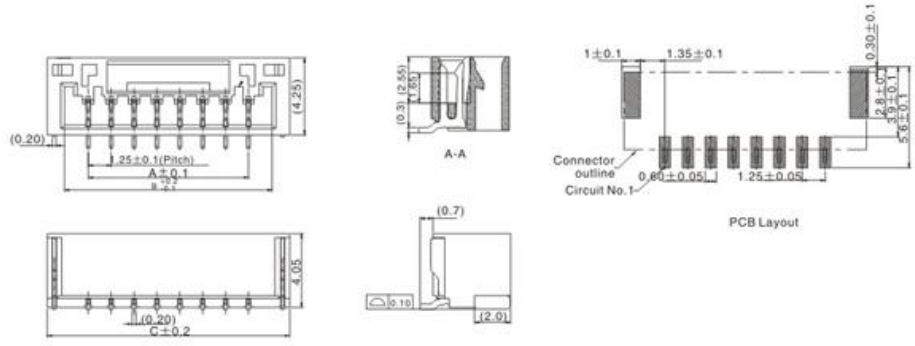

Connector outline
Circuit No. 1

PCB Layout

PIN	A	B	C
2	1.25	3.85	5.75
3	2.5	5.1	7
4	3.75	6.35	8.25
5	5	7.6	9.5
6	6.25	8.85	10.75
7	7.5	10.1	12
8	8.75	11.35	13.25
9	10	12.6	14.5
10	11.25	13.85	15.75
11	12.5	15.1	17
12	13.75	16.35	18.25
13	15	17.6	19.5
14	16.25	18.85	20.75
15	17.5	20.1	22
18	21.25	23.85	25.75
20	23.75	26.35	28.25

SPECIFICATION

- Material:
 - Housing: HIGH-TEMP Plastic, UL94V-0, color: Natural.
 - Contacts: Copper alloy.
 - Solder tab: Copper alloy.
- Electrical Characteristics:
 - Current rating: 1A(max).
 - Voltage rating: 200V(max).
 - Operating Temperature: -25°C~+85°C.
 - Insulation resistance: 1000M ohms min. at 1000V DC
 - Dielectric withstanding voltage: 1000AC/minute.
 - Contact resistance: 30m ohms max.

WAFER 1.25MM XP REVERSE SINKING-BOARD TYPE

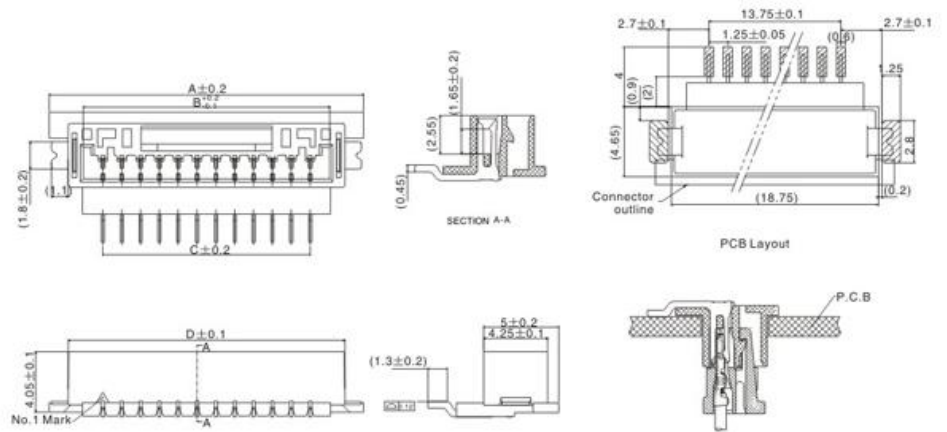

Connector outline
P.C.B.

PIN	A	B	C	D
2	8.35	3.85	1.25	5.85
3	9.60	5.10	2.50	7.10
4	10.85	6.35	3.75	8.35
5	12.10	7.60	5.00	9.60
6	13.35	8.85	6.25	10.85
7	14.60	10.10	7.50	12.10
8	15.85	11.35	8.75	13.35
9	17.10	12.60	10.00	14.60
10	18.35	13.85	11.25	15.85
11	19.60	15.10	12.50	17.10
12	20.85	16.35	13.75	18.35
13	22.10	17.60	15.00	19.60
14	23.35	18.85	16.25	20.85
15	24.60	20.10	17.50	22.10
16	25.85	21.35	18.75	23.35
17	27.10	22.60	20.00	24.60
18	28.35	23.85	21.25	25.85

SPECIFICATION

- Material:
 - Housing: HIGH-TEMP Plastic, UL94V-0, color: Natural.
 - Contacts: Copper alloy.
 - Solder tab: Copper alloy.
- Electrical Characteristics:
 - Current rating: 1A(max).
 - Voltage rating: 200V(max).
 - Operating Temperature: -25°C~+85°C.
 - Insulation resistance: 1000M ohms min. at 1000V DC
 - Dielectric withstanding voltage: 1000AC/minute.
 - Contact resistance: 30m ohms max.

WAFER 1.25MM 2XP VERTICAL ENTRY TYPE

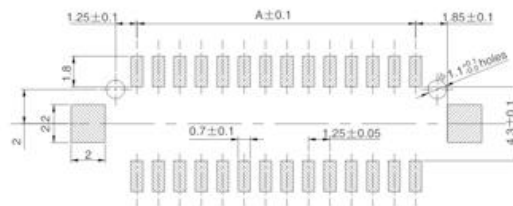
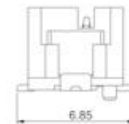
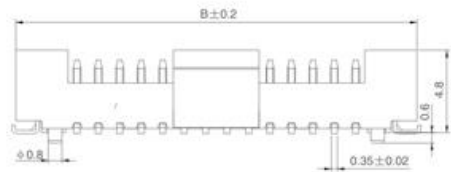
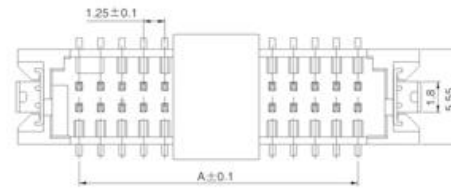
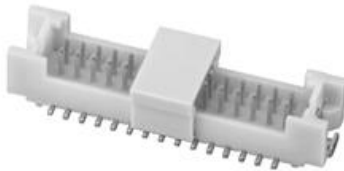

PCB Layout

PART NO	Dimensions	
	A	B
2X5 PIN	5.00	12.15
2X7 PIN	7.50	14.65
2X10 PIN	11.25	18.40
2X15 PIN	17.50	24.65
2X20 PIN	23.75	30.90

SPECIFICATION

- Material:
 - Housing: HIGH-TEMP Plastic, UL94V-0, color: Natural.
 - Contacts: Copper alloy.
 - Solder tab: Copper alloy.
- Electrical Characteristics:
 - Current rating: 1A(max).
 - Voltage rating: 200V(max).
 - Operating Temperature: -25°C~+85°C.
 - Insulation resistance: 1000M ohms min. at 1000V DC
 - Dielectric withstanding voltage: 1000AC/minute.
 - Contact resistance: 30m ohms max.

WAFER 3.0MM 3P DIP180

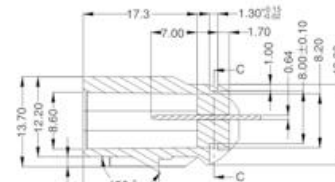
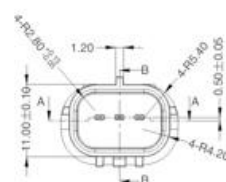

SECTION B-B

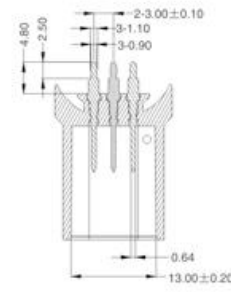
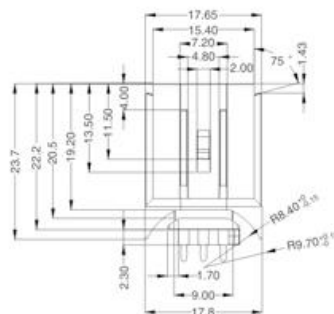

SECTION A-A

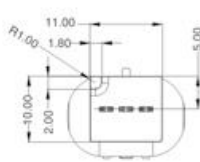

DIM S OF PCB HOLE

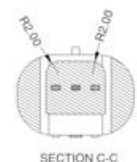

SECTION C-C

SPECIFICATION

- Material:
 - Housing: HIGH-TEMP Plastic, UL94V-0, color: Natural.
 - Contacts: Copper alloy.
 - Solder tab: Copper alloy.
- Electrical Characteristics:
 - Current rating: 1A(max).
 - Voltage rating: 200V(max).
 - Operating Temperature: -25°C~+85°C.
 - Insulation resistance: 1000M ohms min. at 1000V DC
 - Dielectric withstanding voltage: 1000AC/minute.
 - Contact resistance: 30m ohms max.

HDMI 19P FEMALE SMT

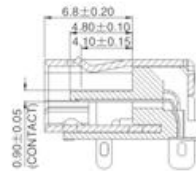
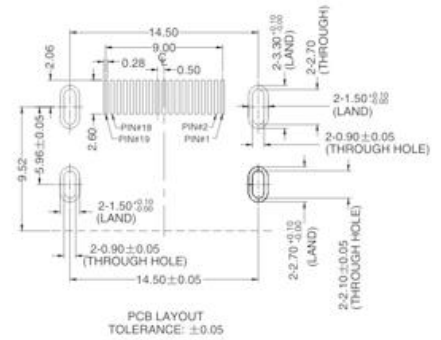
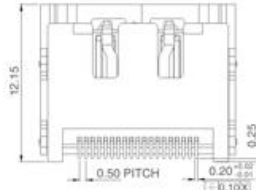
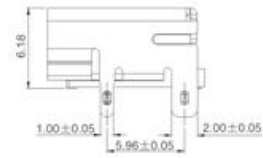
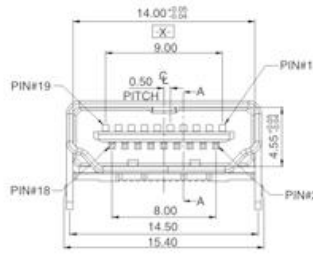

SECTION A-A
SCALE 1:1

SPCCFICTIONS:

1.ELECTRICAL CHARACTERISTICS:

- 1.1 CONTACT CURRENT RATING:0.5A Min.
- 1.2 VOLTAGE RATING: 40V AC.
- 1.3 CONTACT RESISTANCE: 30mΩ Max.
- 1.4 INSULATION REISITANCE: 100MΩ Min.
- 1.5 DIELECTRIC STRENGTH: 500V AC/3 minute.

2.MECHANICAL:

- 2.1 INSERTION FORCE: 4.4 kgf Max.
- 2.2 WITHDRAWAL FORCE: 0.98 kgf Min.
- 2.3 RETENTION FORCE: 600gf Min/Pin

3.ENVIRONMENTAL:

- 3.1 OPERATING TEMPERATURE:-25℃ TO +85℃

4.DIM. MARKED ①②③.....SHOULD BE CONTROLLED BY QC

HDMI 19P FEMALE VERTICAL ENTRY TYPE

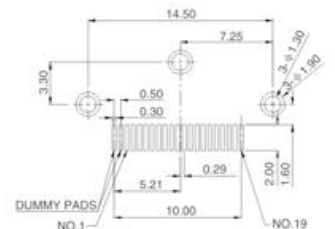
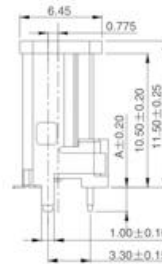
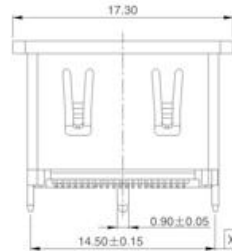
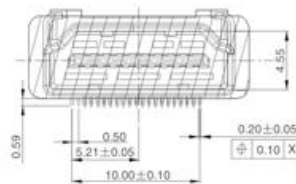

RECOMMEN P.C.B LAYOUT(T=1.6mm)
TOLERANCES UNLESS OTHERWISE SPEC ±0.05

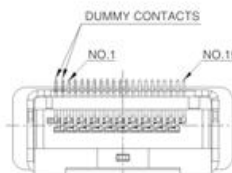

COMPONENT MATERIAL& SURFACE TREATMENT

- (1)SHELL
1.BRONZE
2.NICKEL 1.27um(Min)
- (2)CONTACT
1.BRONZE
2.NICKEL 0.51um(Min)
3.Au 0.05um(Min)

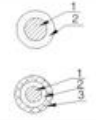

- 1.Contact Restance: ≤30mΩ
- 2.Insulation Resistance: ≥100mΩ
- 3.Withstand Voltage: AC 500V (50HZ)/min
4. "A"~"E" Important Size

MINI HDMI 19P FEMALE SMT

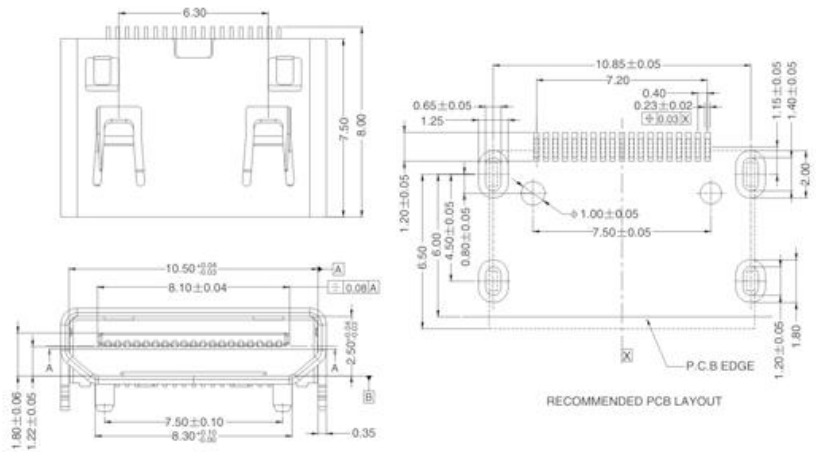

SPECIFICATION:

1. MATING FORCE: 44.1N MAX.
2. UNMATING FORCE: 7~25N
3. DURABILITY: 5000 CYCLES MIN
4. CURRENT: 0.5A
5. VOLTAGE: 40V MAX
6. WITHSTANDING VOLTAGE: 500V AC MIN. (UNMATED)
300V AC MIN. (MATED)
7. CONTACT RESISTANCE: 30mΩ MAX
8. INSULATION RESISTANCE: 100MΩ MIN. (UNMATED)
10MΩ (MATED)
9. OPERATING TEMPERATURE RANGE: -20°C TO +85°C
10. ALL THE MATERIAL SHOULD COMPLY WITH POHS REQUIREMENT

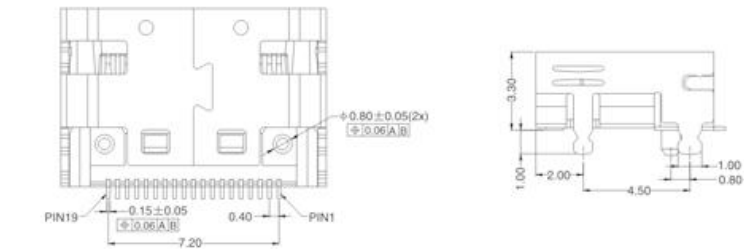

MINI HDMI 19P FEMALE SINKING-BOARD TYPE

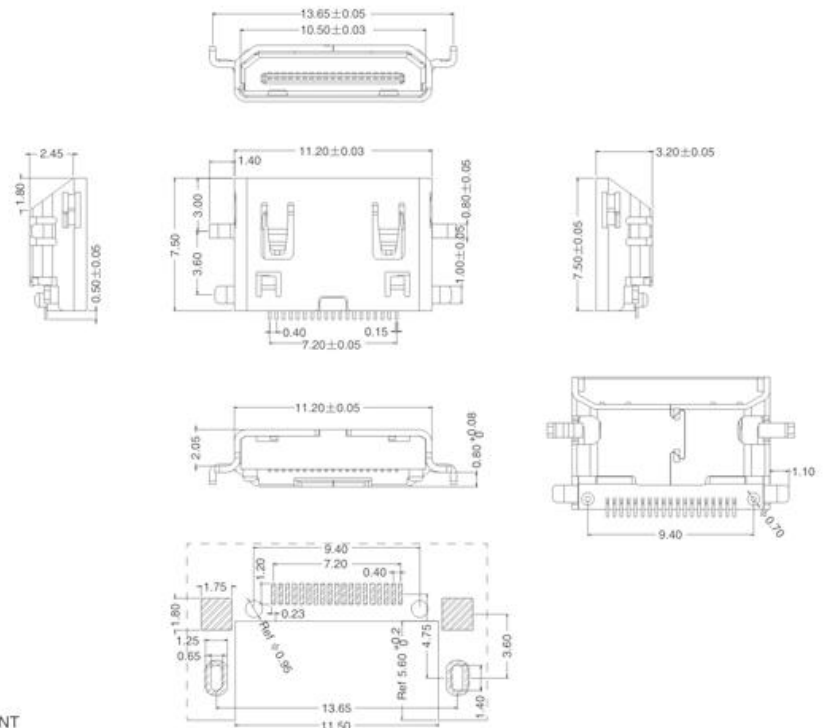

SPECIFICATION:

1. MATING FORCE: 44.1N MAX.
2. UNMATING FORCE: 7~25N
3. DURABILITY: 5000 CYCLES MIN
4. CURRENT: 0.5A
5. VOLTAGE: 40V MAX
6. WITHSTANDING VOLTAGE: 500V AC MIN. (UNMATED)
7. CONTACT RESISTANCE: 30mΩ MAX
8. INSULATION RESISTANCE: 100MΩ MIN. (UNMATED)
9. OPERATING TEMPERATURE RANGE: -20°C TO +85°C
10. ALL THE MATERIAL SHOULD COMPLY WITH ROHS REQUIREMENT

RJ45 8P DIP90 100BASE LED WITH SHRAPNEL

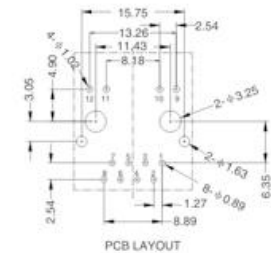
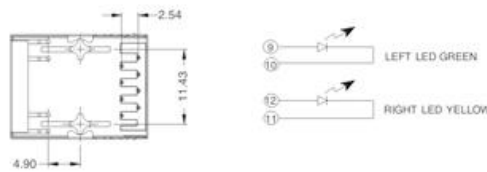
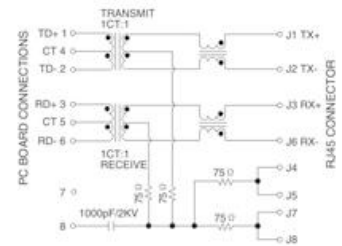
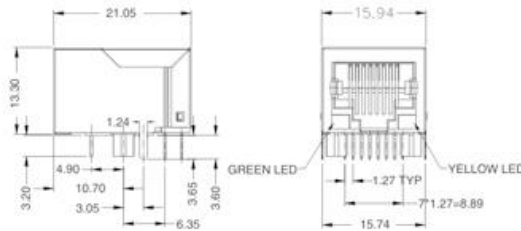

- MATERIAL:**
Housing:PBT,UL94V-0,Black.
Terminal:C5210R-EH,AU 5U[™] plating at contact area.
- MECHANICAL:**
Durability: 750 cycles
Operation temperature:-40°C +85°C.
Normal force at mated position:100g min.
- ELECTRICAL:**
1.Voltage rating:125V AC.
2.Insulation resistance:1000 megohms MIN @500VDC.
3.Contact resistance:50 milliohms Max.
4.T/R:RX=1CT:1CT(+/-5%) & TX=1CT:1CT.
5.OCL:350uH Min at 100KHz/0.1Vrms with 8mA Bias From 0°C TO 70°C.
6.Insertion Loss:-1.0dB Max 1MHZ TO 100MHZ.
7.Retn Loss:-16dB Min From 1MHz To 30MHz;
-14dB Min From 30MHz To 60MHz;
-10dB Min From 60MHz To 80MHz;
8.Cross Talk:-40dB Min From 1MHz To 30MHz;
-35dB Min From 30MHz To 60MHz;
-30dB Min From 60MHz To 100MHz;
9.CMR:-35dB Min From 1MHz To 100MHz;
10.Hi-Pot:1500V AC 6S 1mA.

Specification LED

Standard LED Color	LED Wavelength	Forward (V MAX)	Typical (V TYP)	Luminous Intensity
Green	560-580 nm	2.5V	2.1-2.2V	9-25 MCD
Yellow	580-610 nm	2.5V	2.1-2.2V	9-30 MCD

RJ45 8P DIP90 100BASE LED WITHOUT SHRAPNEL

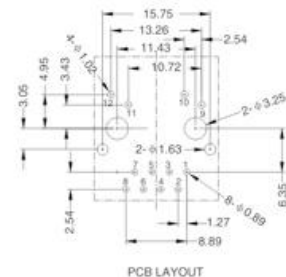
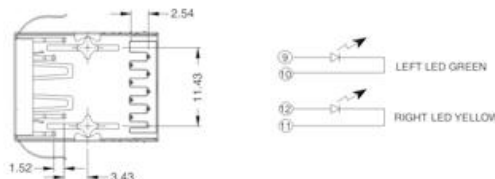
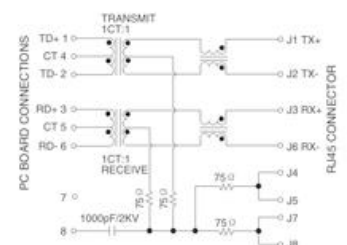
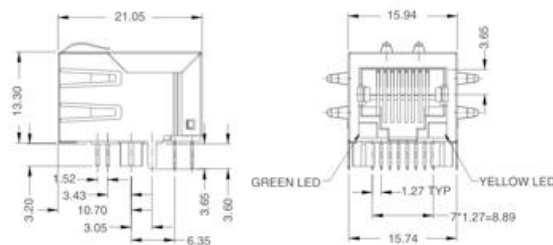

- MATERIAL:**
Housing:PBT,UL94V-0,Black.
Terminal:C5210R-EH,AU 5U[™] plating at contact area.
- MECHANICAL:**
Durability: 750 cycles
Operation temperature:-40°C +85°C.
Normal force at mated position:100g min.
- ELECTRICAL:**
1.Voltage rating:125V AC.
2.Insulation resistance:1000 megohms MIN @500VDC.
3.Contact resistance:50 milliohms Max.
4.T/R:RX=1CT:1CT(+/-5%) & TX=1CT:1CT.
5.OCL:350uH Min at 100KHz/0.1Vrms with 8mA Bias From 0°C TO 70°C.
6.Insertion Loss:-1.0dB Max 1MHZ TO 100MHZ.
7.Retn Loss:-16dB Min From 1MHz To 30MHz;
-14dB Min From 30MHz To 60MHz;
-10dB Min From 60MHz To 80MHz;
8.Cross Talk:-40dB Min From 1MHz To 30MHz;
-35dB Min From 30MHz To 60MHz;
-30dB Min From 60MHz To 100MHz;
9.CMR:-35dB Min From 1MHz To 100MHz;
10.Hi-Pot:1500V AC 6S 1mA.

Specification LED

Standard LED Color	LED Wavelength	Forward (V MAX)	Typical (V TYP)	Luminous Intensity
Green	560-580 nm	2.5V	2.1-2.2V	9-25 MCD
Yellow	580-610 nm	2.5V	2.1-2.2V	9-30 MCD

RJ45 8P DIP90 1000BASE LED

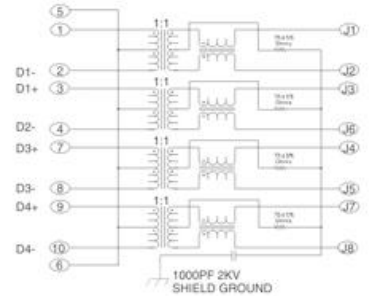
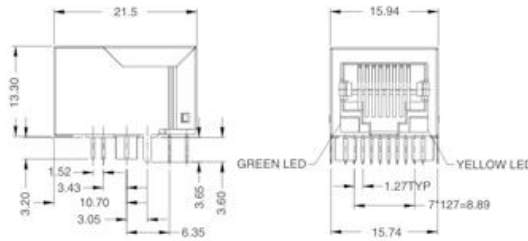

- MATERIAL:**
Housing: PBT, UL94V-0, Black.
Terminal: C5210R-EH, AU 5U[™] plating at contact area.
- MECHANICAL:**
Durability: 750 cycles
Operation temperature: -40°C +85°C.
Normal force at mated position: 100g min.
- ELECTRICAL:**
1. Voltage rating: 125V AC.
2. Insulation resistance: 1000 megohms MIN @500VDC.
3. Contact resistance: 50 milliohms Max.
4. T/R: RX=1CT:1CT(+/-5%) & TX=1CT:1CT.
5. OCL: 350uH Min at 100KHz/0.1Vrms with 8mA Bias From 0°C TO 70°C.
6. Insertion Loss: -1.0dB Max 1MHZ TO 100MHZ.
7. Retn Loss: -16dB Min From 1MHZ To 30MHZ;
-14dB Min From 30MHZ To 60MHZ;
-10dB Min From 60MHZ To 80MHZ;
8. Cross Talk: -40dB Min From 1MHZ To 30MHZ;
-35dB Min From 30MHZ To 60MHZ;
-30dB Min From 60MHZ To 100MHZ;
9. CMR: -35dB Min From 1MHZ To 100MHZ;
10. Hi-Pot: 1500V AC 6S 1mA.

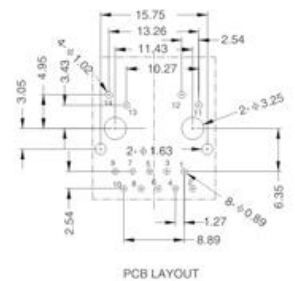
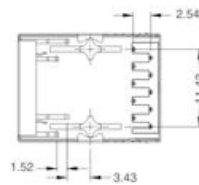

Specification LED

Standard LED Color	LED Wavelength	Forward (V MAX)	Typical (V TYP)	Luminous Intensity
Green	560-580 nm	2.5V	2.1-2.2V	9-25 MCD
Yellow	580-610 nm	2.5V	2.1-2.2V	9-30 MCD

RJ45 8P DIP180 100BASE LED

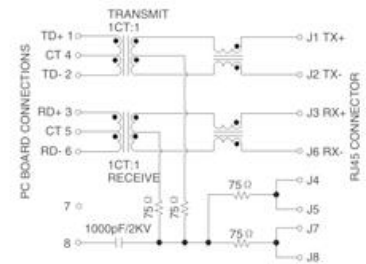
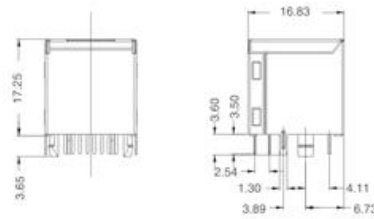

- MATERIAL:**
Housing: PBT, UL94V-0, Black.
Terminal: C5210R-EH, AU 5U[™] plating at contact area.
- MECHANICAL:**
Durability: 750 cycles
Operation temperature: -40°C +85°C.
Normal force at mated position: 100g min.
- ELECTRICAL:**
1. Voltage rating: 125V AC.
2. Insulation resistance: 1000 megohms MIN @500VDC.
3. Contact resistance: 50 milliohms Max.
4. T/R: RX=1CT:1CT(+/-5%) & TX=1CT:1CT.
5. OCL: 350uH Min at 100KHz/0.1Vrms with 8mA Bias From 0°C TO 70°C.
6. Insertion Loss: -1.0dB Max 1MHZ TO 100MHZ.
7. Retn Loss: -16dB Min From 1MHZ To 30MHZ;
-14dB Min From 30MHZ To 60MHZ;
-10dB Min From 60MHZ To 80MHZ;
8. Cross Talk: -40dB Min From 1MHZ To 30MHZ;
-35dB Min From 30MHZ To 60MHZ;
-30dB Min From 60MHZ To 100MHZ;
9. CMR: -35dB Min From 1MHZ To 100MHZ;
10. Hi-Pot: 1500V AC 6S 1mA.

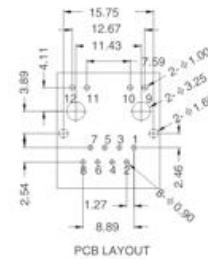
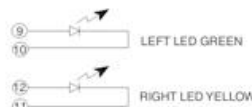
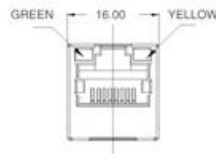

Specification LED

Standard LED Color	LED Wavelength	Forward (V MAX)	Typical (V TYP)	Luminous Intensity
Green	560-580 nm	2.5V	2.1-2.2V	9-25 MCD
Yellow	580-610 nm	2.5V	2.1-2.2V	9-30 MCD

CSCONN ELECTRONICS (SHENZHEN) CO. , LTD

ADD: NO. 398 Minzhi Road Longhua Block Baoan District Shenzhen City China.

Tel: 0755-81718789 Fax: 0755-28169337

E-mail: ivanxiao@cconn.com

<http://www.cconn.com>

CSCONN GROUP (HONGKONG) LIMITED

ADD: Room 1103 Hang Seng Mongkok Building 677 Nathan Road Mongkok Kowlong Hong Kong.

Tel: 00852-21361626 Fax: 00852-21366546

E-mail: allendong@cconn.com

<http://www.cconn.com>